

A

x1

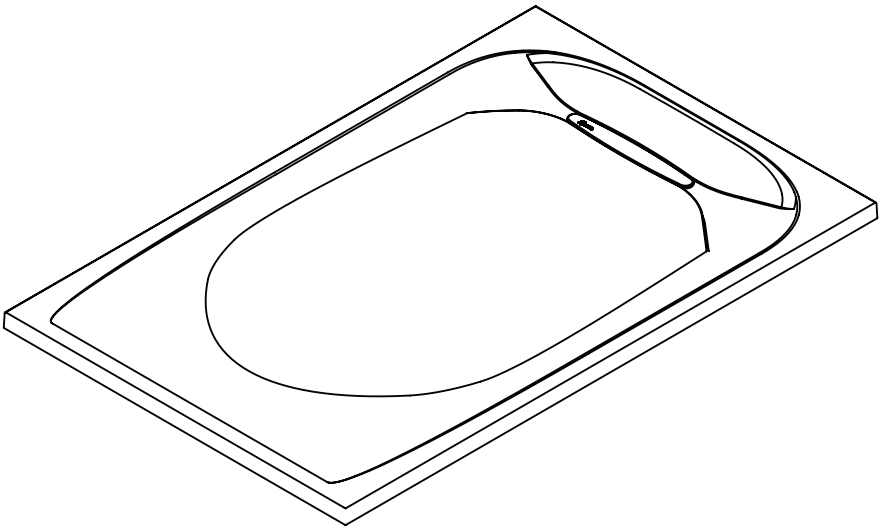

100x80	REC939	120x100	REC943				
100x90	REC940	140x80	REC944	160x80	REC947	180x80	REC950
120x80	REC941	140x90	REC945	160x90	REC948	180x90	REC951
120x90	REC942	140x100	REC946	160x100	REC949	180x100	REC952

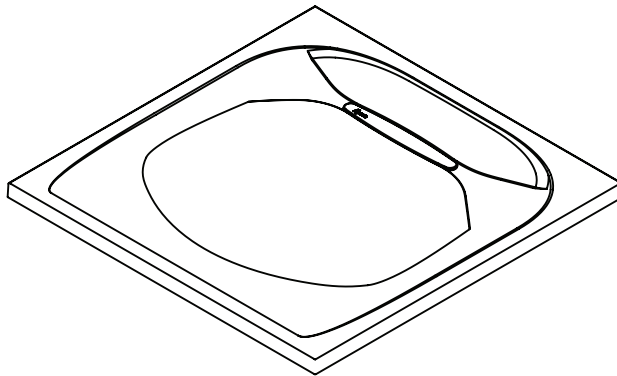

90x90	REC937
100x100	REC938

B

x1



CAP29

C

x1

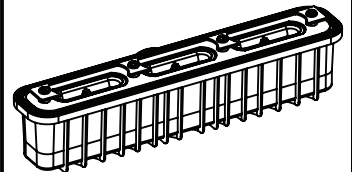

BOND46

FR - Les quantités données sont les quantités utiles au montage. les sachets fournis contiennent des pièces supplémentaires.

GB - The quantities given are what are required for the installation. There may be some surplus in the package provide.

ES - Las cantidades indicadas son las cantidades necesarias para el montaje. Las bolsitas incluidas contienen piezas suplementarias.

PT - A quantidade indicada é a quantidade necessária para a montagem. As bolsas incluem peças adicionais.

IT - Le quantità fornite sono le quantità necessarie al montaggio. I sacchetti forniti contengono pezzi supplementari.

NL - De aangegeven aantallen zijn bestemd voor de montage. De bijgeleverde zakjes bevatten extra onderdelen

DE - Die Mengenangaben beziehen sich auf die für die Montage benötigten Teile. Es kann eine gewisse Überzahl an Teilen in der Packung vorhanden sein.

FR-Matériel nécessaire GB-Tools required
ES-Equipamiento necesario PT-Equipamento necessário
IT-Materiale necessario NL-Benodigd gereedschap DE-Benötigte Werkzeuge

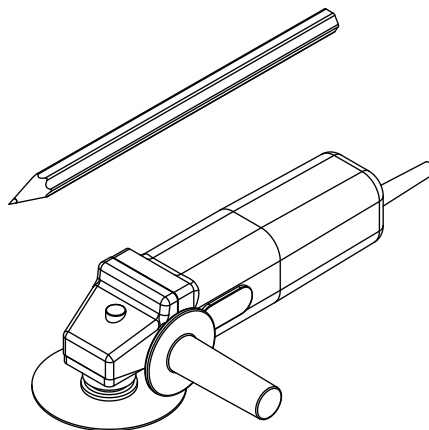
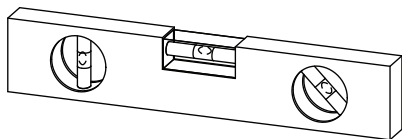

FR-Meuleuse avec lame diamant Ø230mm mini.
GB-Grinder with diamond blade Ø230mm mini.
ES-Amoladora con hoja de diamante Ø230mm mini.
PT-Moedor com lâmina de diamante Ø230mm mini.
IT-Mola con lama diamantata Ø230mm mini.
NL-Slijpmachine met diamantzaagblad Ø230 mm mini.
DE-Winkelschleifer mit Diamanttrennscheibe Ø230mm mini.



FR-Utiliser un silicone adapté au matériau de chaque support (faïence, acrylique, etc.)
GB-Use a silicone sealant that is suitable for the surrounding materials (ceramic, acrylic, etc)
ES-Utilizar silicona adecuada para el material de cada soporte (loza, acrílico, etc.)
PT-Use um silicone adequado para o material de cada suporte (faiança, acrílico, etc.)
IT-Utilizzare silicone adatto per il materiale di ogni supporto (porcellana, acrilico, ecc.)
NL-Gebruik een silicone die geschikt is voor het materiaal van elke steun (keramiek, acryl, enz.)
DE-Verwenden Sie ein geeignetes Silikon für das Material der Duschwanne (Steingut, Acryl, etc.)

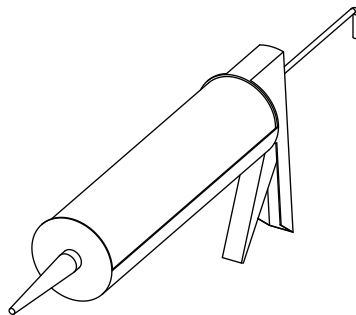

FR-Colle POLYURETHANE ou MS POLYMERE
GB-POLYURETHANE or MS POLYMER glue
ES-Adhesivo POLIURETANO o MS POLYMERE
PT-Cola POLIURETANICA ou MS POLYMERE
IT-Colla POLIURETANICA ou MS POLYMERE
NL-POLYURETHAAN- of MS-POLYMEERLIJM
DE-POLYURETHAN oder MS POLYMER KLEBER



FR-DECOUPE OPTIONNELLE DU RECEVEUR GB-ZONE AVAILABLE FOR OPTIONAL RECUTTING

ES-CORTE OPCIONAL PT-RECORTE OPCIONAL

IT-TAGLIO OPZIONALE DEL PIATTO NL-ZAGEN VAN DE DOUCHEBAK, OPTINEEL

DE-OPTIONALE SCHNEIDBEREICHE DER DUSCHWANNE

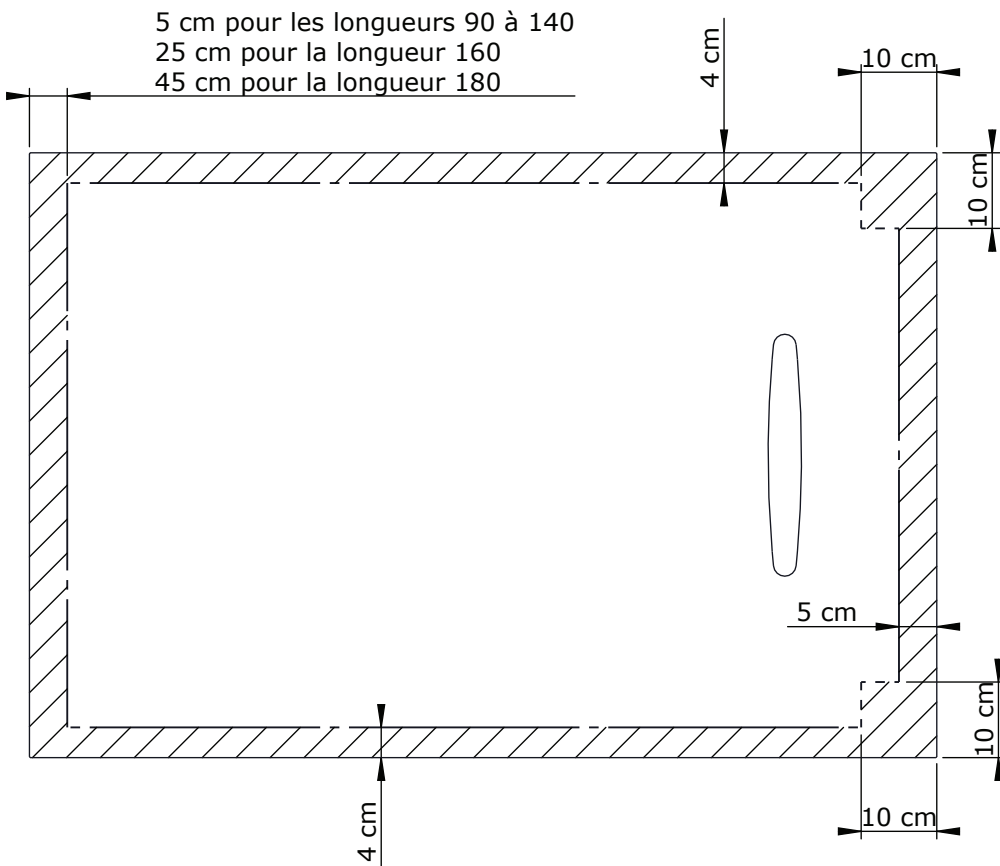

FR-Zone MAXI découpable

GB-MAX cuttable area

ES-Zona MAXIMA de recorte

PT-Limite MAXIMO de corte

IT-Limite MASSIMO di taglio

NL-MAXIMAAL aanpasbaar deel

DE-MAXIMALER Schneidbereich

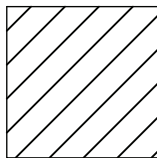

1

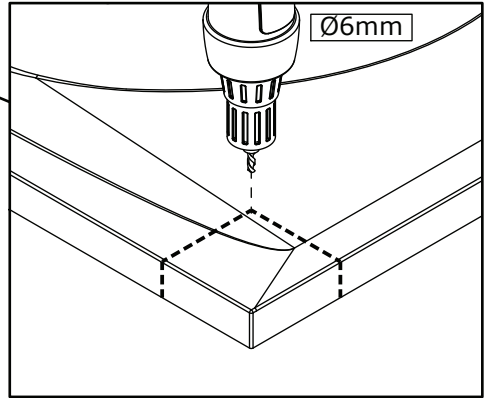
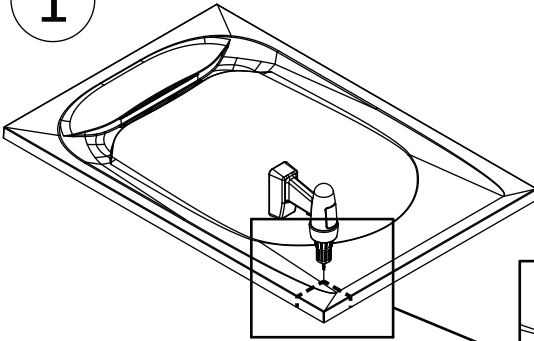

2

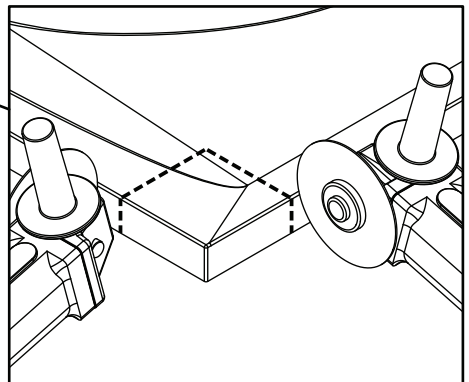
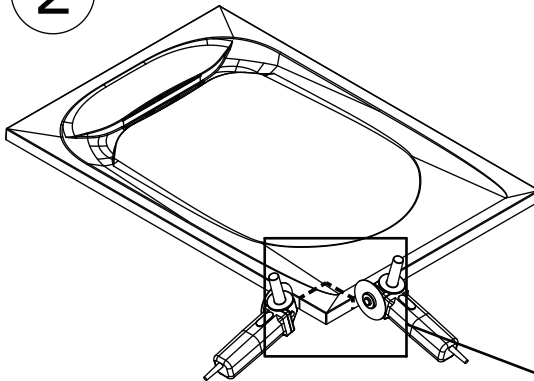

3



FR-Appliquer une couche de colle polyuréthane ou MS polymère à l'aide d'une spatule sur la surface coupée

et combler l'espace entre les nervures du receveur avec une couche de mortier adhésif.

GB-Apply a polyurethan adhesive or MS polymer layer using a spatula over the raw surface and fill the space

between the ribs of the tray with a layer of adhesive mortar.

ES-Aplicar una capa de pegamento poliuretano o polímero MS en la superficie recortada. Puede ayudarse de

una espátula y rellenar los espacios huecos del plato con una capa de mortero adhesivo.

PT-Aplique uma camada de cola de poliuretano ou polímero MS na superfície cortada com uma espátula e preencha o espaço vazio da base com uma camada de argamassa selante.

IT-Applicare della colla poliuretana o MS polimero con l'aiuto di una spatola sulla parte tagliato e

compensare lo spazio tra le venature del piatto con uno strato di materiale adesivo.

NL-Breng met een spatel een laag polyurethaan lijm of MS polymeer lijm aan op de zaagranden, en vul de

tussenliggende ruimte tot het steunoppervlak van de douchebak op met een laag cement.

DE-Wenn Sie ihre Duschtasse zuschneiden, müssen die Schnittkanten mittels Polyurethan- oder MS-Polymer-Klebstoff versiegelt werden.

Tragen Sie die Versiegelung mit einem Spachtel auf der Schnittfläche bis unterhalb der Duschtasse auf.

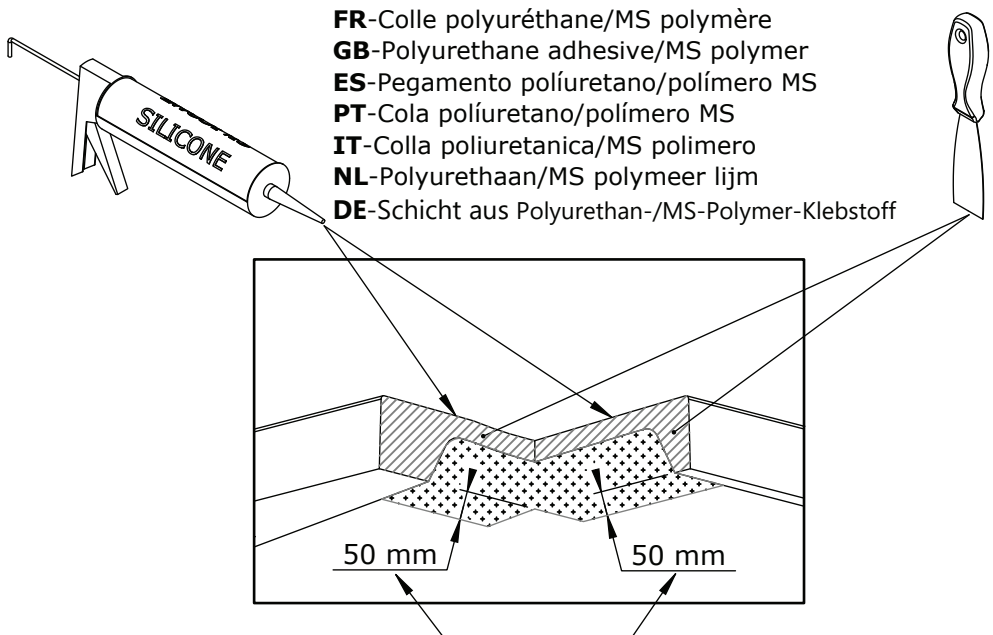

FR-Couche de 50mm de mortier adhésif **GB**-50mm layer of adhesive mortar

ES-Capa de 50mm de grosor de mortero adhesivo

PT-Camada de 50mm de argamassa selante

IT-Strato di 50mm di materiale adesivo

NL-Laag van 50mm lijm mortel **DE**-50 mm x Schnittlänge mit Klebstoff auffüllen

FR-Nombre de pieds **GB**-Feet quantity **ES**-Cantidad de pies
PT-Quantidade de pés **IT**-Quantità di piedin
NL-Hoeveelheid voeten **DE**-Zahl der FüÙe

90x90 5	100x80 5	100x90 5	100x100 5	120x80 6	120x90 6	120x100 6	140x80 6
140x90 6	140x100 6	160x80 7	160x90 7	160x100 7	180x80 7	180x90 7	180x100 7

FR - La distance bord à bord entre deux pieds ne doit pas être de plus de 30 cm.
 LES PIEDS DOIVENT ETRE INSTALLES SUR LES NERVURES DU RECEVEUR.

GB - The distance from the edge of the shower tray to the edge of a peripheral support should be no more than 30 cm.
 THE FEET MUST BE INSTALLED ON THE SHOWER TRAY RIBS.

ES - La distancia entre cada pie no debe superar los 30 cm.
 LOS PIES DEBEN ESTAR INSTALADOS SIGUIENDO LAS NERVIOS DEL PLATO.

PT - A distância entre dois pés não deve exceder 30cm.
 OS PÉS DEVEM SER INSTALADOS NAS NERVURAS DA BASE DE DUCHE.

IT - Ladistanza tra due piedi non dovrebbe essere superiore a 30 cm.
 I PIEDI DEVONO ESSERE ISTALLATI SULLE NERVATURE DEL PIATTO DOCCIA.

NL - De afstand tussen twee stelpoten mag niet meer dan 30 cm bedragen.
 DE STELPOTEN DIENEN OP HET STEUNOPPERVLAK VAN DE DOUCHEBAK GEÏNSTALLEERD TE WORDEN.

DE - Der Abstand zwischen zwei verstellbaren FüÙen darf 30 cm nicht überschreiten.
 DIE FÜÙE MÜSSEN AUF DEN VERSTÄRKUNGSSTREBEN DER DUSCHTASSE MONTIERT WERDEN.



http://tiny.cc/notice_pieds_kinediva

FR

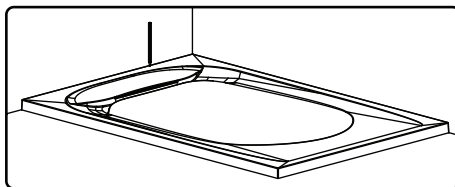

Tracer la position de la bonde et réaliser un montage à blanc de la bonde et du receveur

- ① - silicone de finition traité antifongique de 5mm de largeur minimum
- ② - silicone d'étanchéité souple traité antifongique
- ③ - élément de soutien du joint silicone
- ④ - silicone d'appui

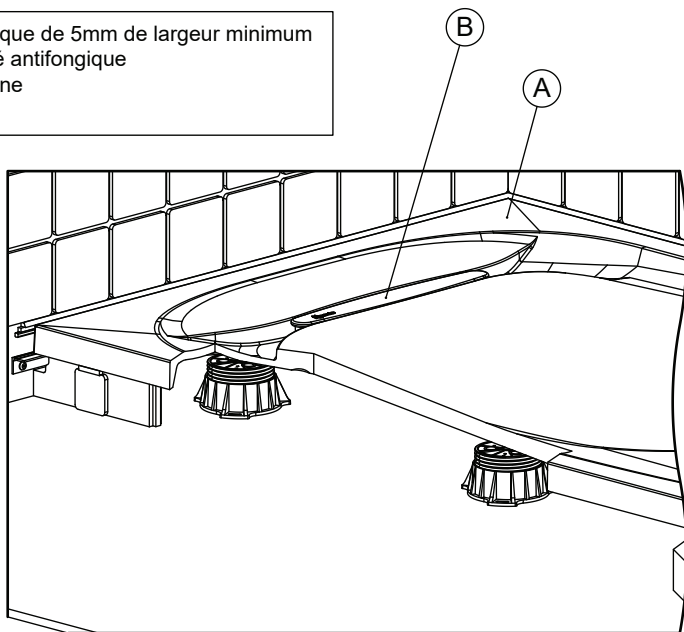
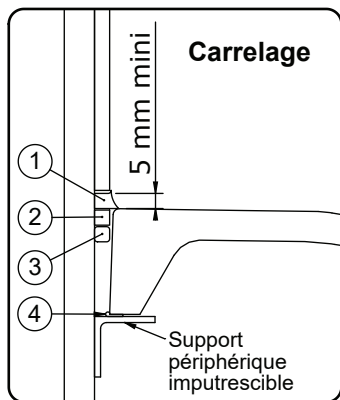

Il est indispensable d'avoir un support imputrescible sur tous les côtés du receveur.

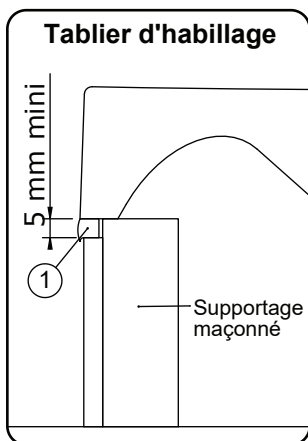
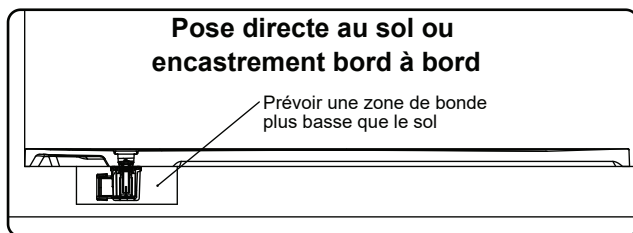

Supportage du fond

Avec pieds fournis en option

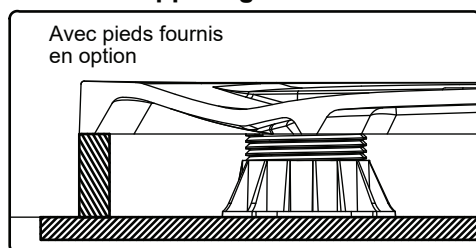



Pendant toute la durée des travaux, protéger le receveur contre toute agression : brûlures, chocs, rayures, découpants...



Le montage d'une *soupape anti-vide* est nécessaire pour une utilisation optimale si un autre appareil sanitaire est raccordé sur la même évacuation.

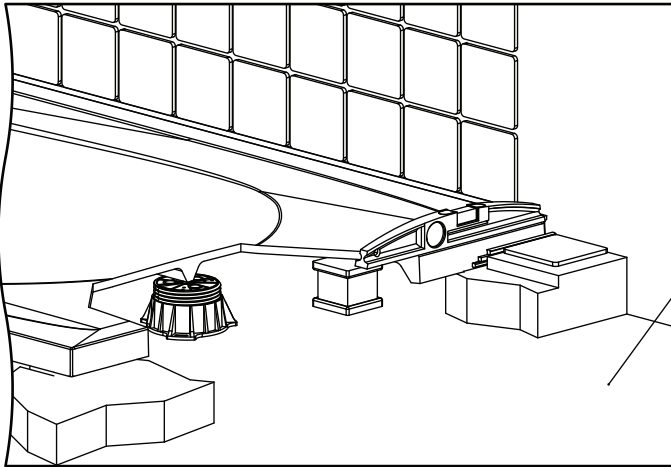

Sol rigide et non humide indispensable.

Ne pas poser sur plancher chauffant.

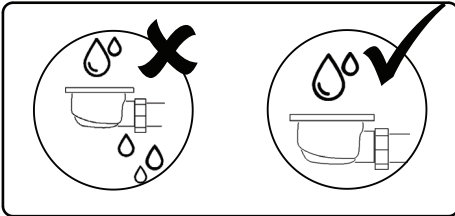

Pose directe au sol

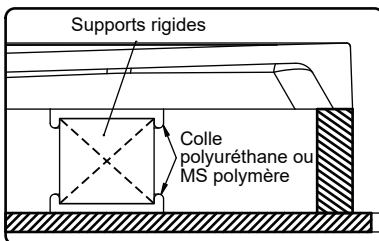
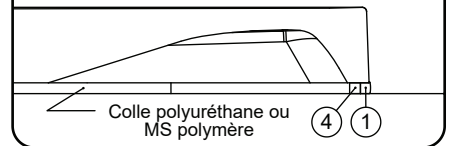

Encastrement bord à bord

5 mm mini

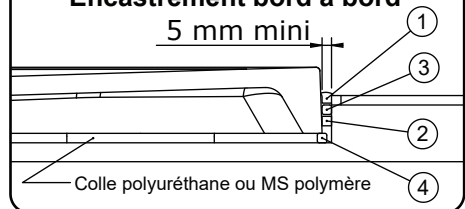

TYPES D'INSTALLATION

	90x90	100x100	100x80	100x90	120x80	120x90	120x100	140x80	140x90	140x100	160x80	160x90	160x100	180x80	180x80	180x80
X	90	100	100	100	120	120	120	140	140	140	160	160	160	180	180	180
Y	90	80	90	100	80	90	100	80	90	100	80	90	100	80	90	100
A	26,5	21,5	26,5	31,5	21,5	26,5	31,5	21,5	26,5	31,5	21,5	26,5	31,5	21,5	26,5	31,5
B	65	75	75	75	95	95	95	115	115	115	135	135	135	155	155	155

1. Posé sur pieds réglables avec habillage carrelé

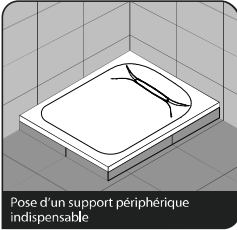

Pose d'un support périphérique indispensable

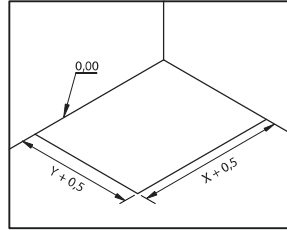
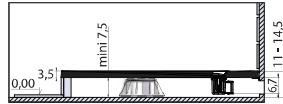

Préparation de l'implantation

2. Posé en butée contre le carrelage

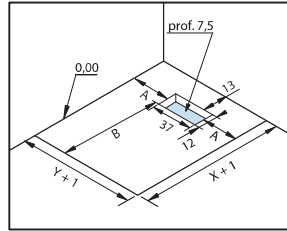
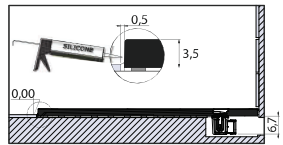
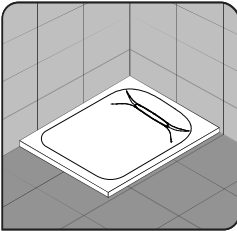

Préparation de l'implantation

3. Encastré et posé sur pieds réglables

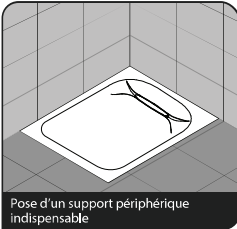

Pose d'un support périphérique indispensable

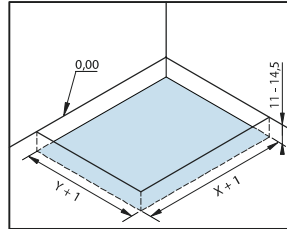
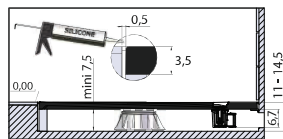

Préparation de l'implantation

4. Encastré et posé sans pieds réglables

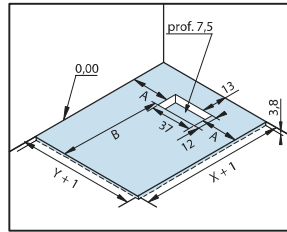
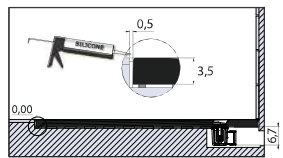
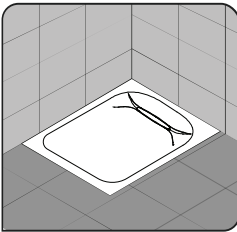

Préparation de l'implantation

FR-Mise en place des plots de colle polyuréthane ou MS polymère

GB-Loading the plots glue polyurethane or MS polymer

ES-Ubicación de los puntos de pegamento poliuretano o polímero MS

PT-Localização dos pontos de cola de poliuretano ou polímero MS

IT-Posizione dei punti di colla poliuretanica o MS polimero

NL-Brenge de polyurethaan lijm of MS polymeer aan op de juiste plaats

DE-Bringen Sie den Polyurethan-/MS-Polymere-Kleber auf

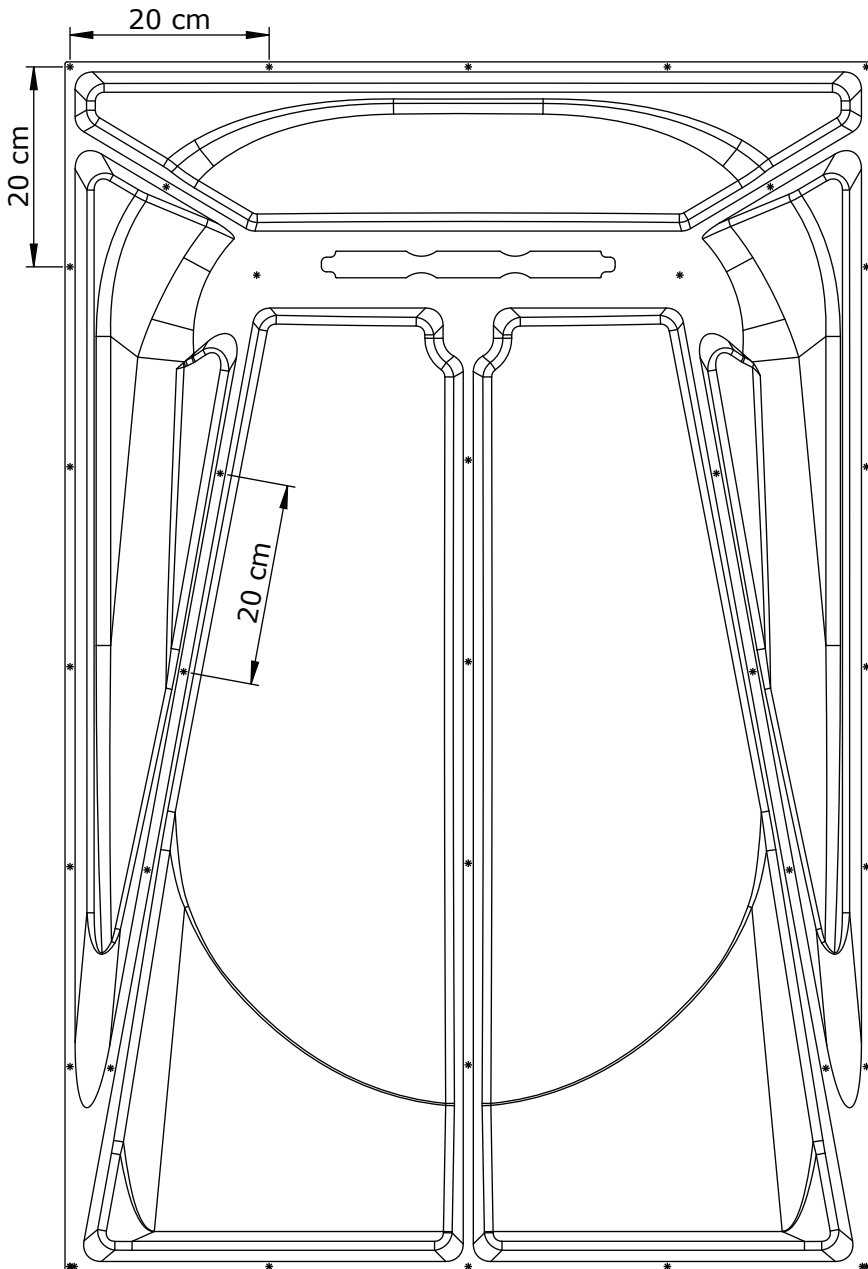

GB

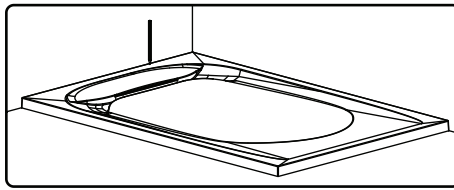

Mark the position of the plug and perform a
White mounting the bung and recipient

- ① - finishing antifungal treated silicone minimum width of 5mm
- ② - flexible sealing silicone treated antifungal
- ③ - support Element silicone seal
- ④ - silicone support

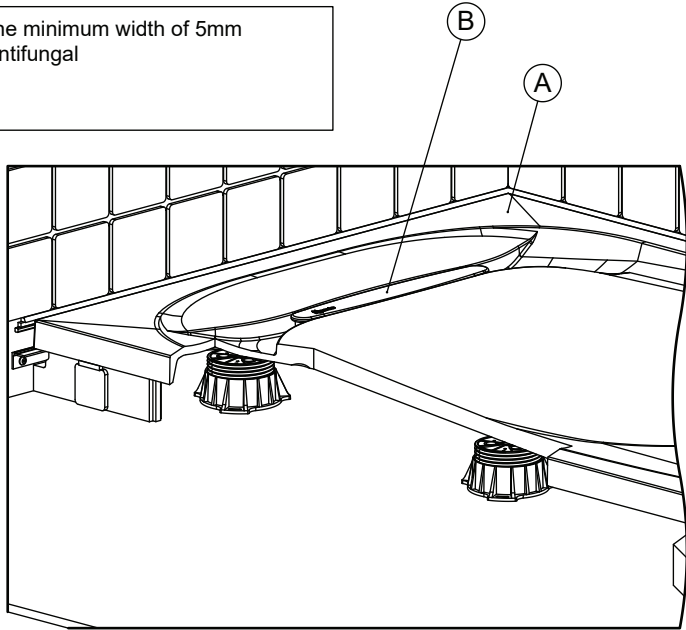
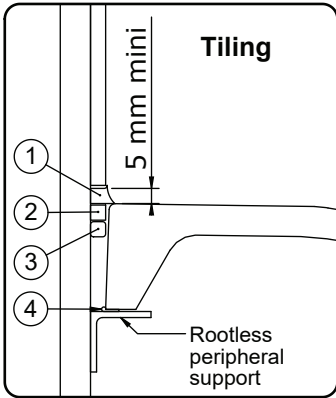

It's essential to have a rigid support on all sides of the shower tray

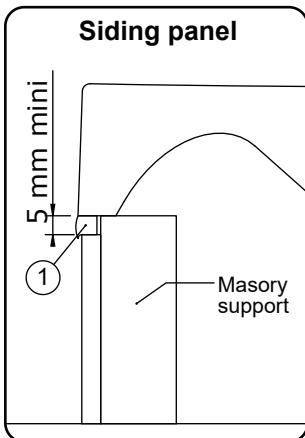
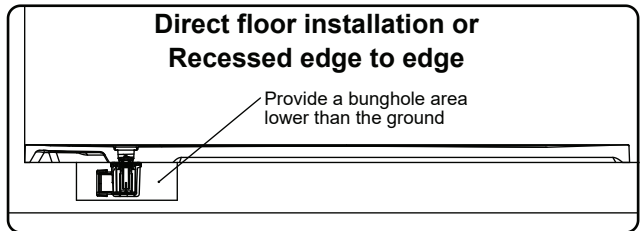

Supporting the bottom

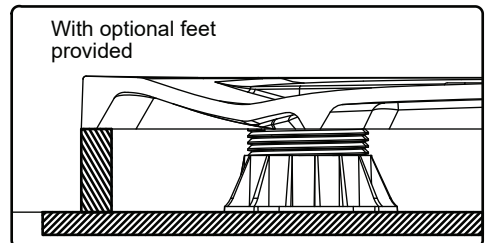

O



The installation of an anti-evacuation valve is necessary for optimum use if another sanitary appliance is connected to the same evacuation

Throughout the duration of the work, protect the recipient against any aggression : burns, shock, scratches, strippers...

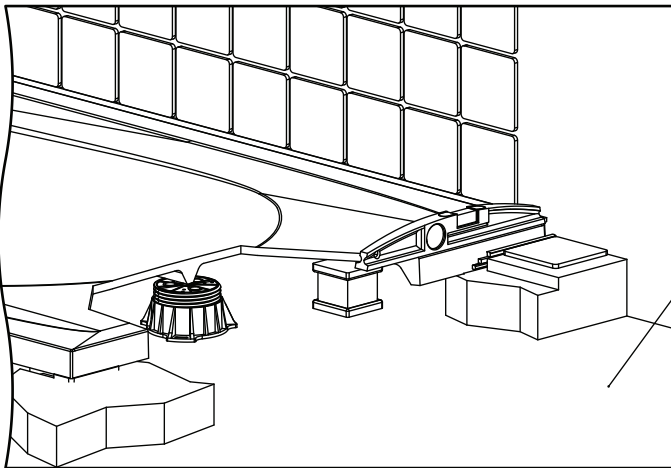

The underlying floor must absolutely be rigid and dry / Ensure a solid dry surface

Do not place on underfloor heating.

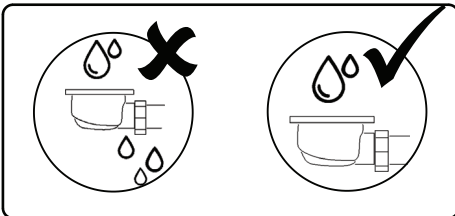

Direct floor installation

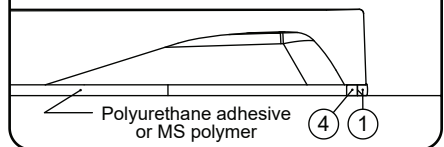

Recessed edge to edge

5 mm mini

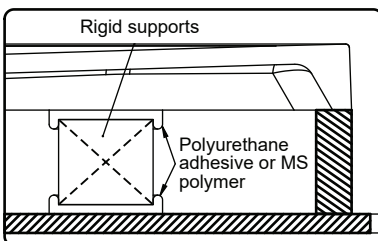
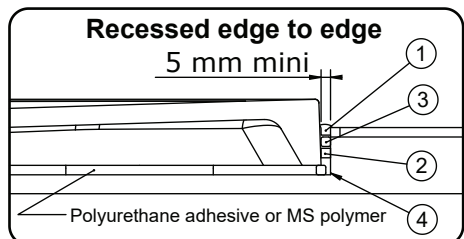

POSSIBLE TYPES OF INSTALLATIONS

	90x90	100x100	100x80	100x90	120x80	120x90	120x100	140x80	140x90	140x100	160x80	160x90	160x100	180x80	180x90	180x100
X	90	100	100	100	120	120	120	140	140	140	160	160	160	180	180	180
Y	90	80	90	100	80	90	100	80	90	100	80	90	100	80	90	100
A	26,5	21,5	26,5	31,5	21,5	26,5	31,5	21,5	26,5	31,5	21,5	26,5	31,5	21,5	26,5	31,5
B	65	75	75	75	95	95	95	115	115	115	135	135	135	155	155	155

1. Mounted on adjustable legs with tiled cladding

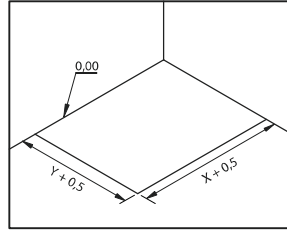
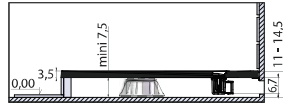

Preparation of the implementation

2. Installed on tiles

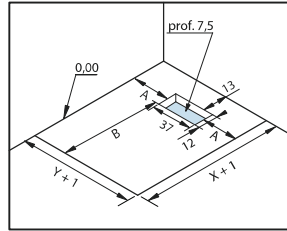
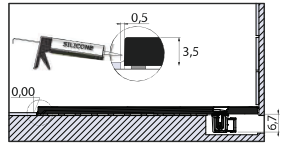
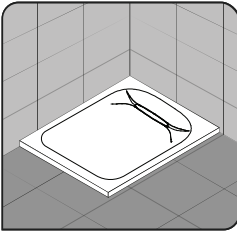

Preparation of the implementation

3. Built-in and placed on adjustable legs

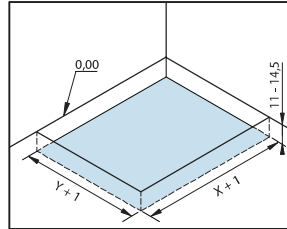
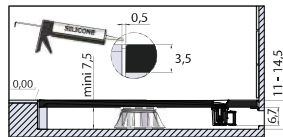

Preparation of the implementation

4. Built-in and installed without adjustable feet

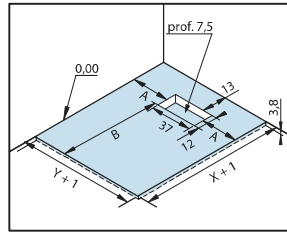
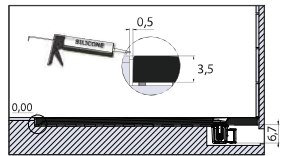
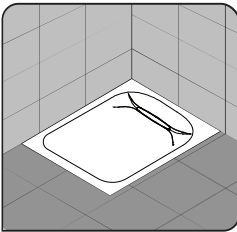

Preparation of the implementation

- FR**-Mise en place des plots de colle polyuréthane ou MS polymère
GB-Loading the plots glue polyurethane or MS polymer
ES-Ubicación de los puntos de pegamento poliuretano o polímero MS
PT-Localização dos pontos de cola de poliuretano ou polímero MS
IT-Posizione dei punti di colla poliuretanica o MS polimero
NL-Brenge de polyurethaan lijm of MS polymeer aan op de juiste plaats
DE-Bringen Sie den Polyurethan-/MS-Polymere-Kleber auf

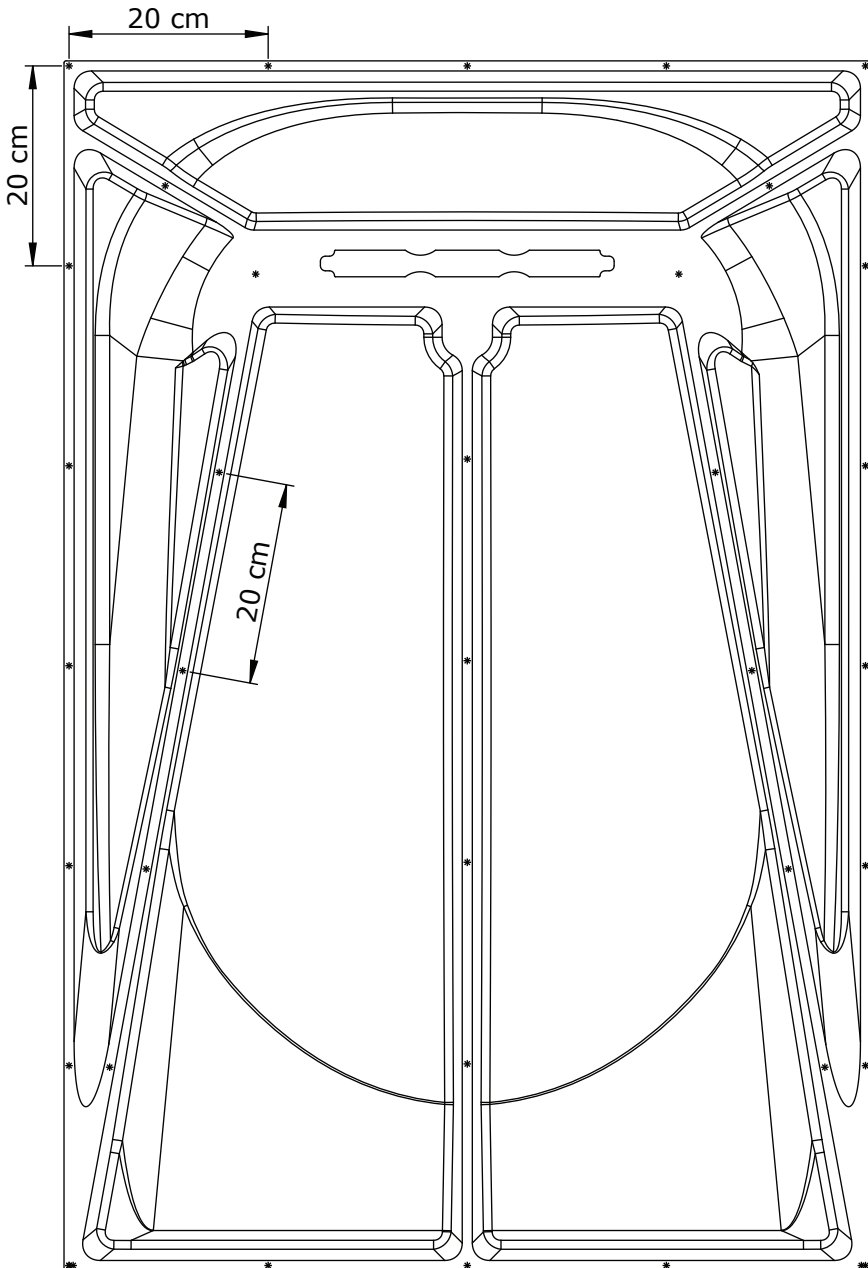

ES

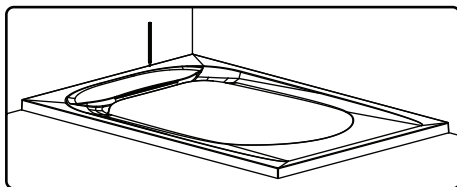

Marcar la ubicación del desagüe y presentar el plato para verificar que esté todo correcto.

- ① - silicona de acabado, antifúngica, 5 mm de anchura mínimo
- ② - silicona de estanqueidad blanda antifúngica
- ③ - elemento de soporte de la junta de silicona
- ④ - silicona de apoyo

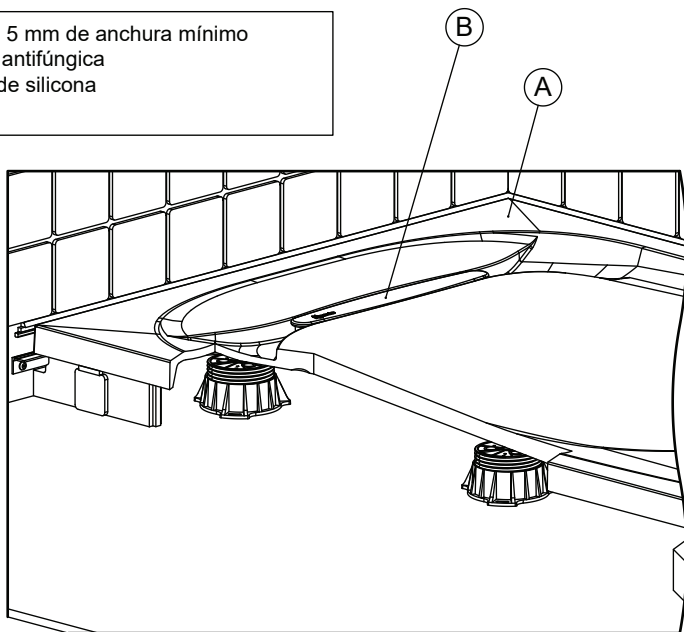
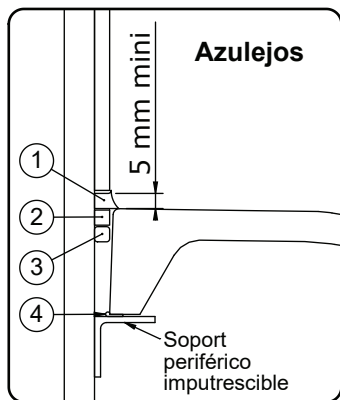

Es imprescindible instalar un soporte imputrescible en todos los lados del plato.

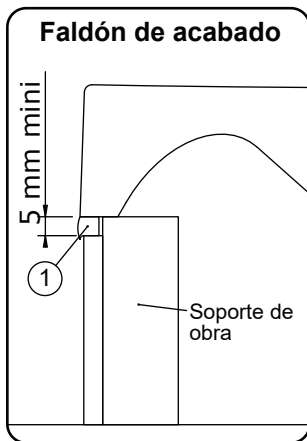
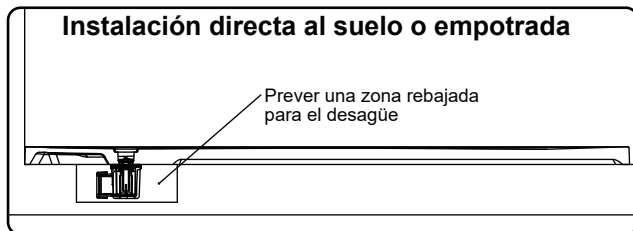

Soportes inferiores

Con pies entregados opcionalmente

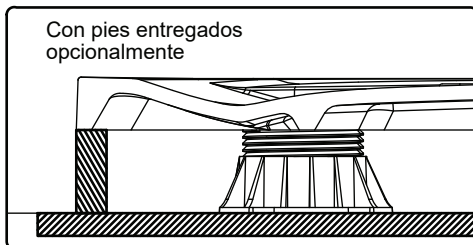



Durante las obras, proteger el plato de ducha de posibles daños como quemaduras, choques, arañazos...



La instalación de una válvula de compensación es necesaria para un uso óptimo, en caso de conectar otro aparato al desagüe del plato.

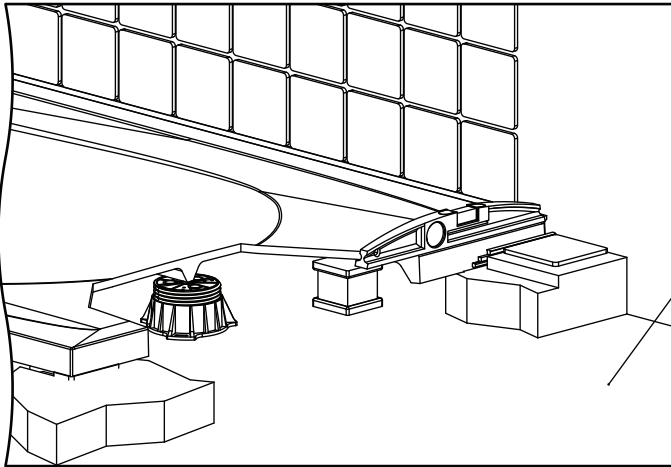

Imprescindible: suelo rígido y sin humedades

No coloque en calefacción por suelo radiante.

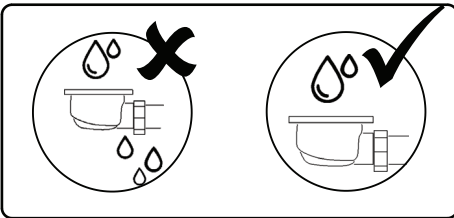

Instalación directa al suelo

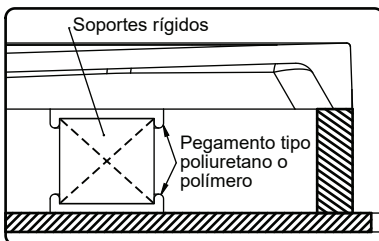
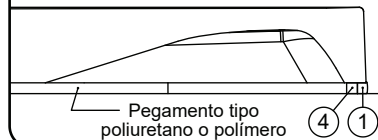

Instalación empotrado en el suelo

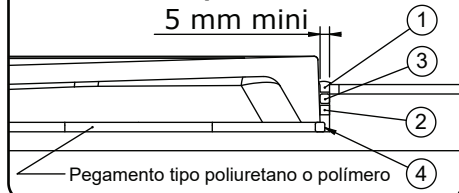

TIPOS DE INSTALACIÓN

	90x90	100x100	100x80	100x90	120x80	120x90	120x100	140x80	140x90	140x100	160x80	160x90	160x100	180x80	180x90	180x100
X	90	100	100	100	120	120	120	140	140	140	160	160	160	180	180	180
Y	90	80	90	100	80	90	100	80	90	100	80	90	100	80	90	100
A	26,5	21,5	26,5	31,5	21,5	26,5	31,5	21,5	26,5	31,5	21,5	26,5	31,5	21,5	26,5	31,5
B	65	75	75	75	95	95	95	115	115	115	135	135	135	155	155	155

1. Instalación sobre pies regulables con revestimiento de baldosas



Instalación de un soporte periférico indispensable

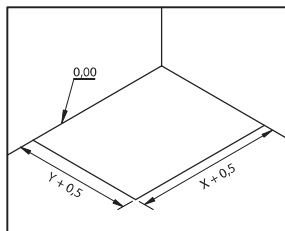
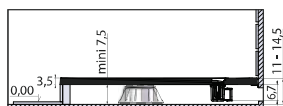

Preparación para la implantación

2. Instalación directa al suelo

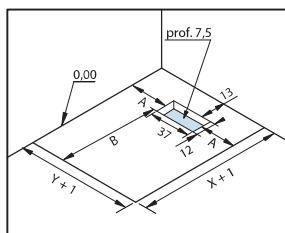
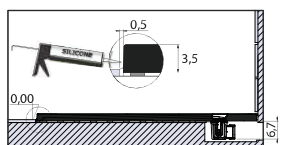
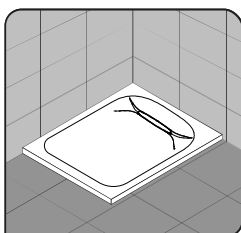

Preparación para la implantación

3. Empotrado e instalado sobre pies regulables



Instalación de un soporte periférico indispensable

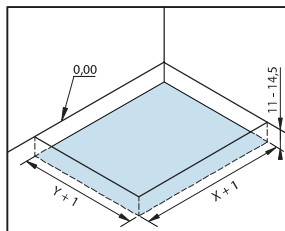
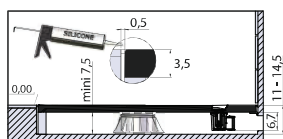

Preparación para la implantación

4. Empotrado e instalado sin pies regulables

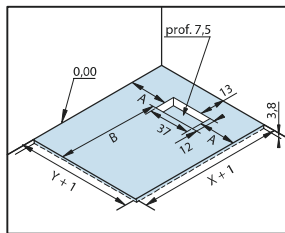
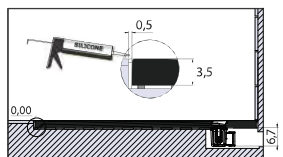
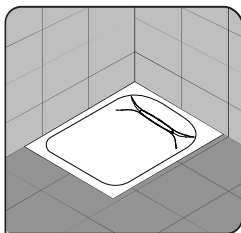

Preparación para la implantación

- FR**-Mise en place des plots de colle polyuréthane ou MS polymère
GB-Loading the plots glue polyurethane or MS polymer
ES-Ubicación de los puntos de pegamento poliuretano o polímero MS
PT-Localização dos pontos de cola de poliuretano ou polímero MS
IT-Posizione dei punti di colla poliuretanica o MS polimero
NL-Brenge de polyurethaan lijm of MS polymeer aan op de juiste plaats
DE-Bringen Sie den Polyurethan-/MS-Polymere-Kleber auf

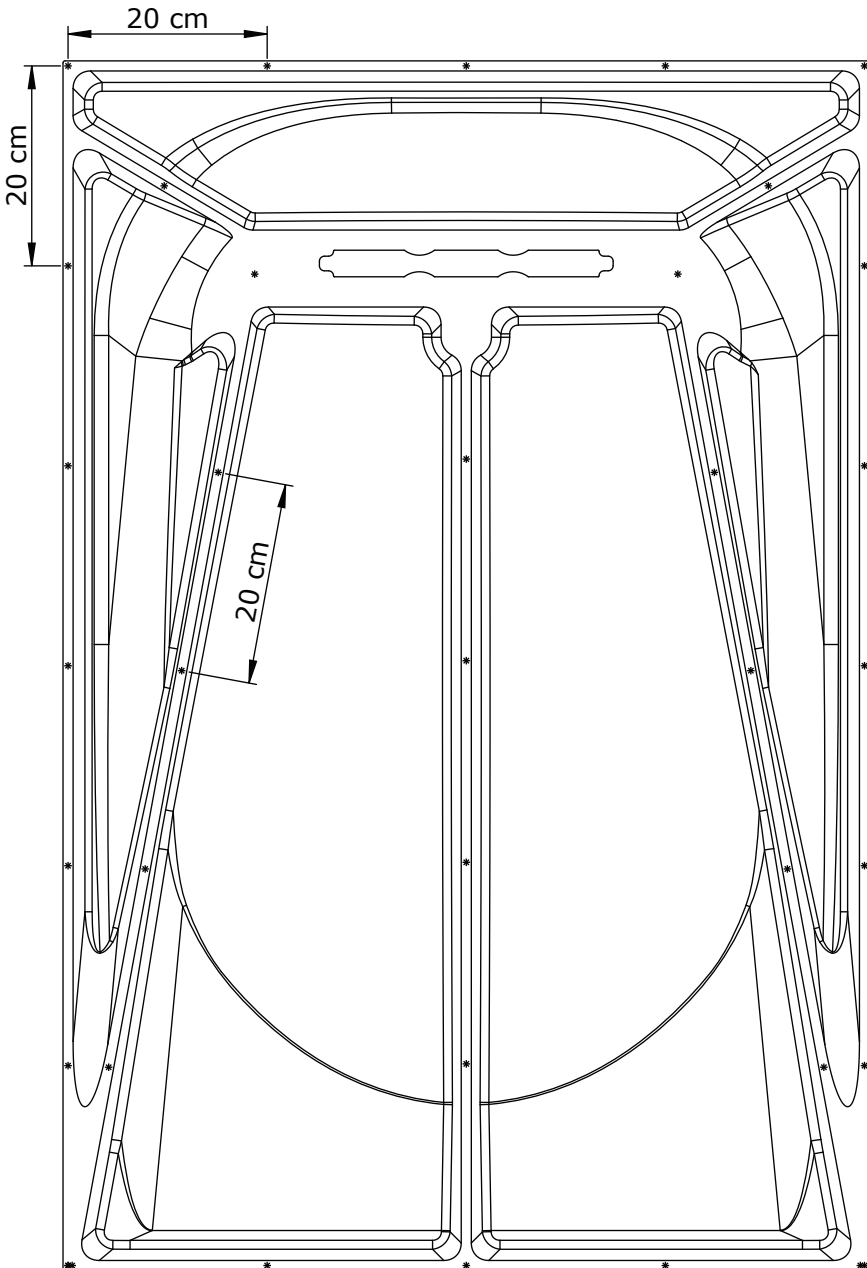

PT

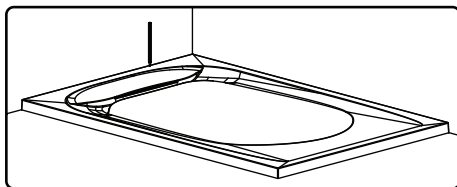

Marcar a localização da válvula e colocar a válvula na base para verificar se a localização é a correta.

- ① - silicone de acabamento, antifúngico com largura mínima de 5 mm
- ② - selante silicone macio com tratamento antifúngico
- ③ - elemento de suporte da junta de silicone
- ④ - suporte de silicone

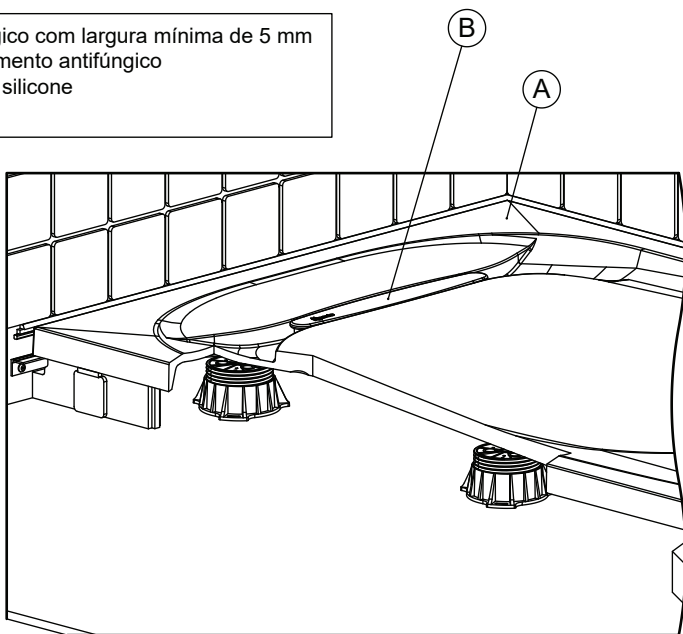
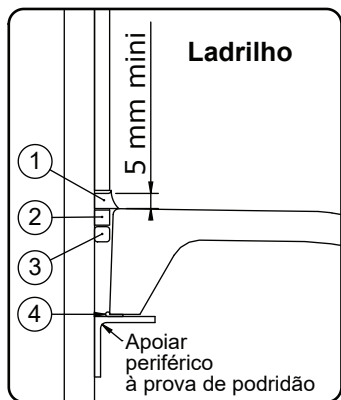

É fundamental instalar um suporte à prova de podridão em todos os lados da placa.

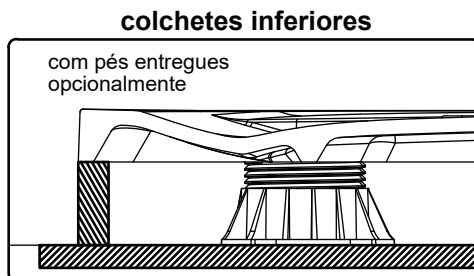
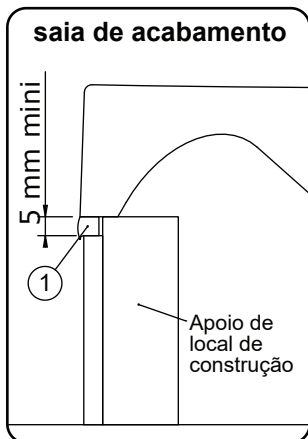
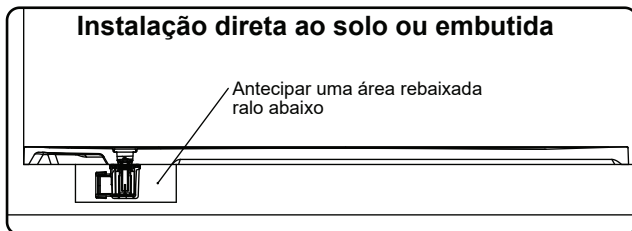



Durante toda a duração da obra, proteger a base de qualquer dano: queimadura, impacto, risco...



Instalar uma válvula anti-vácuo para um bom funcionamento, caso outro elemento sanitário esteja ligado à mesma evacuação.

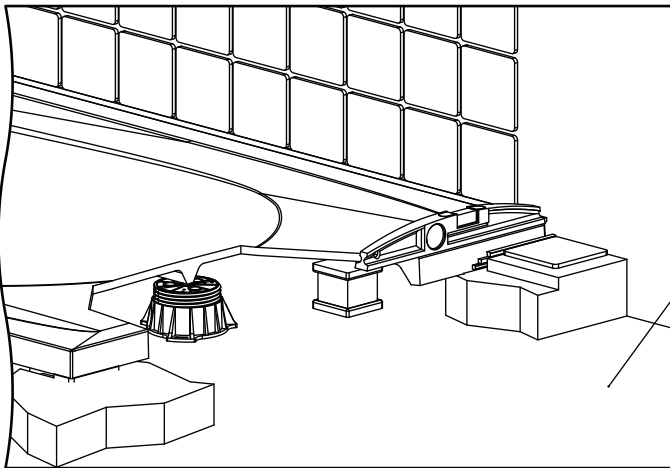

essencial: solo rígido e livre de umidade

não coloque em aquecimento de piso radiante.

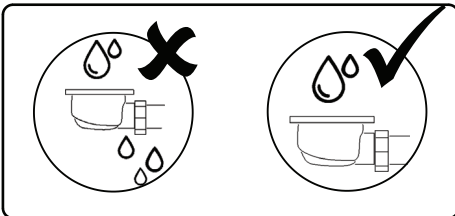

Instalação direta no solo

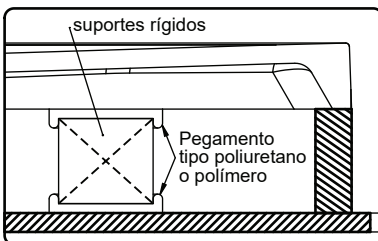
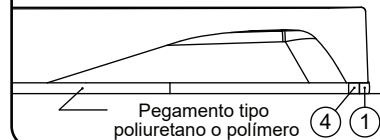

Instalação embutida no solo

5 mm mini



TIPOS DE INSTALAÇÕES POSSÍVEIS

	90x90	100x100	100x80	100x90	120x80	120x90	120x100	140x80	140x90	140x100	160x80	160x90	160x100	180x80	180x90	180x100
X	90	100	100	100	120	120	120	140	140	140	160	160	160	180	180	180
Y	90	80	90	100	80	90	100	80	90	100	80	90	100	80	90	100
A	26,5	21,5	26,5	31,5	21,5	26,5	31,5	21,5	26,5	31,5	21,5	26,5	31,5	21,5	26,5	31,5
B	65	75	75	75	95	95	95	115	115	115	135	135	135	155	155	155

1. Instalação em pés ajustáveis com cobertura de azulejo



Instalação de um suporte periférico essencial

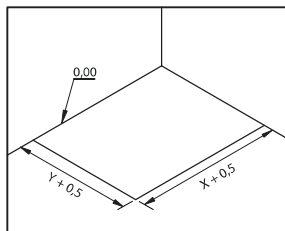
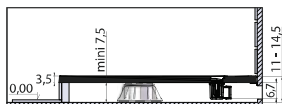

Preparação da execução

2. Deitado em azulejos

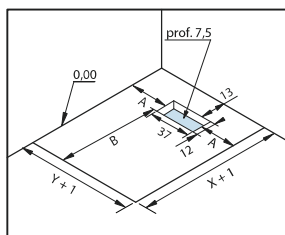
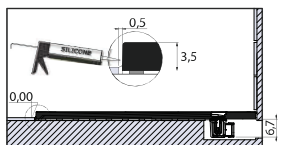
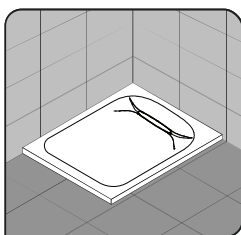

Preparação da execução

3. Recesso e instalação com pés ajustáveis



Instalação de um suporte periférico essencial

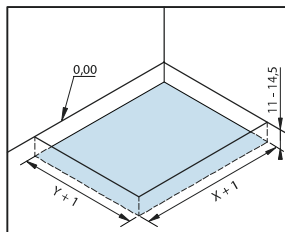
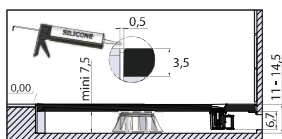

Preparação da execução

4. Recesso e instalação sem pés reguláveis

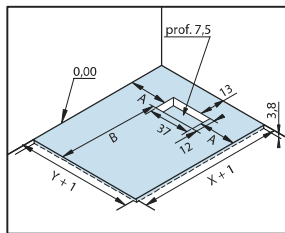
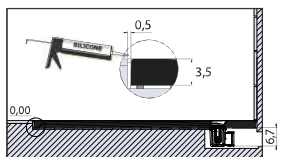
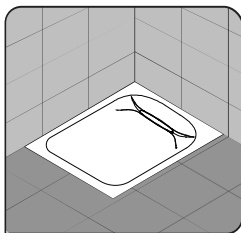

Preparação da execução

- FR**-Mise en place des plots de colle polyuréthane ou MS polymère
GB-Loading the plots glue polyurethane or MS polymer
ES-Ubicación de los puntos de pegamento poliuretano o polímero MS
PT-Localização dos pontos de cola de poliuretano ou polímero MS
IT-Posizione dei punti di colla poliuretanica o MS polimero
NL-Brenge de polyurethaan lijm of MS polymeer aan op de juiste plaats
DE-Bringen Sie den Polyurethan-/MS-Polymere-Kleber auf

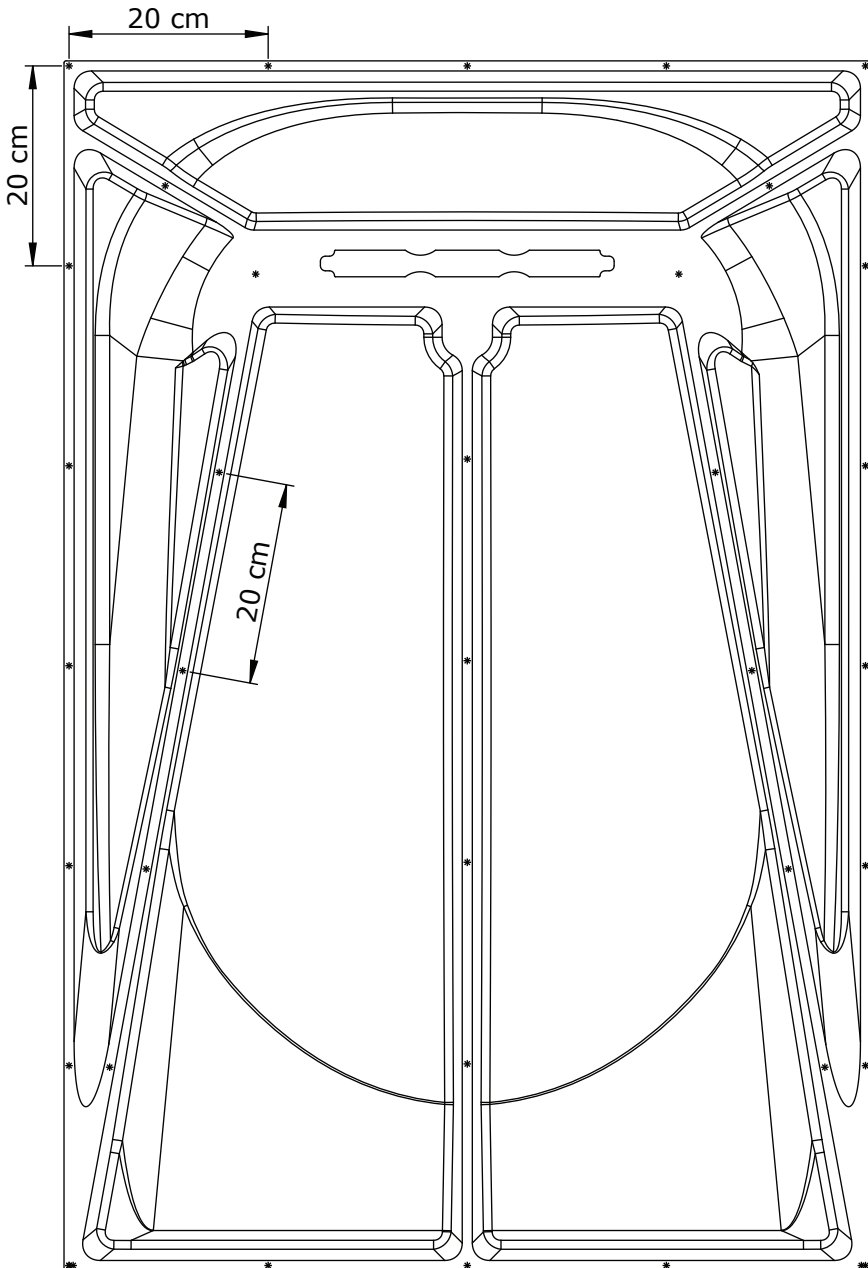

IT

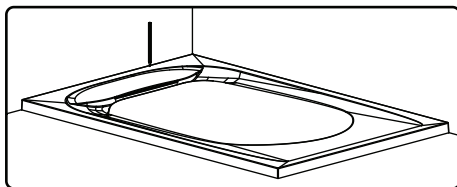

Tracciare la posizione dello scarico e fare un Montaggio cieco dello scarico e della vaschetta.

- ① - silicone di finitura antimuffa di larghezza minima di 5mm
- ② - Silicone morbido sigillante antimuffa
- ③ - elemento di supporto silicone
- ④ - supporto di silicone

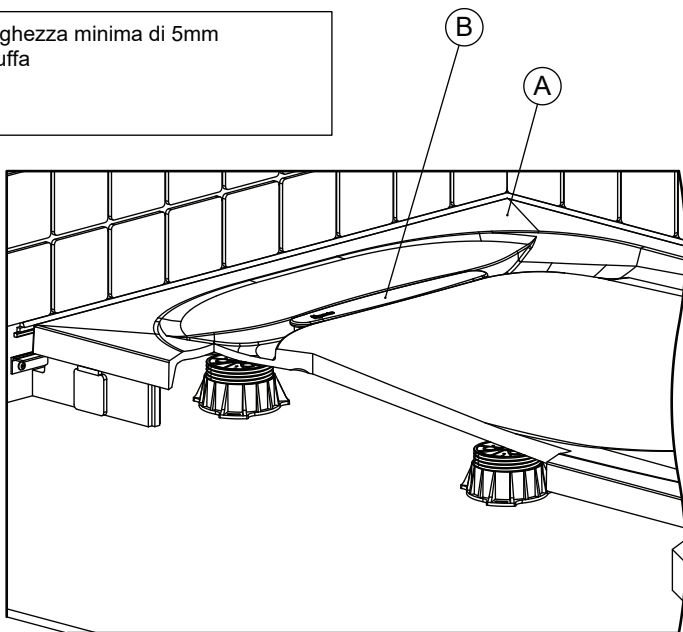
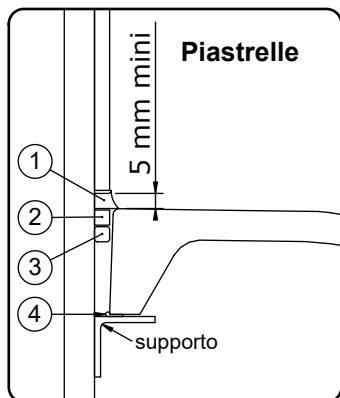

è indispensabile avere un supporto antimuffa su tutti i lati del piatto

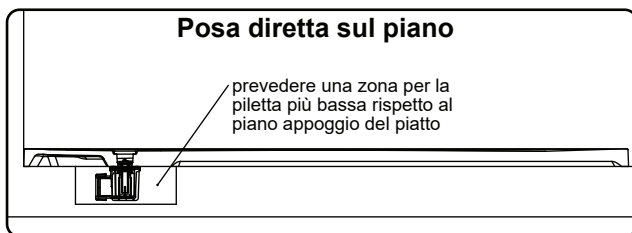

Pannello rivestimento

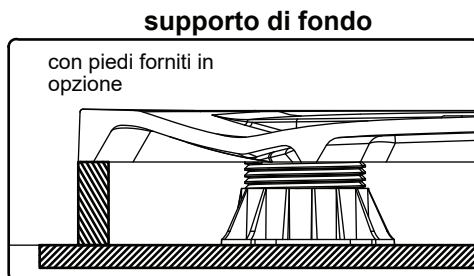
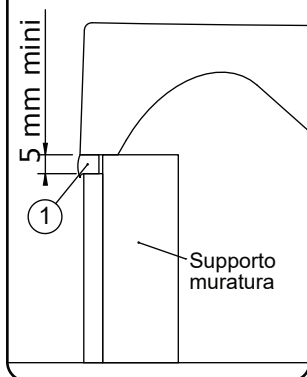



Durante tutta la durata dei lavori
proteggere il piatto da eventuali
abrasioni, colpi o rottura



Installazione di una valvola antivoto
è necessario per l'uso ottimale se
un altro apparecchio sanitario è
collegato allo stesso scarico

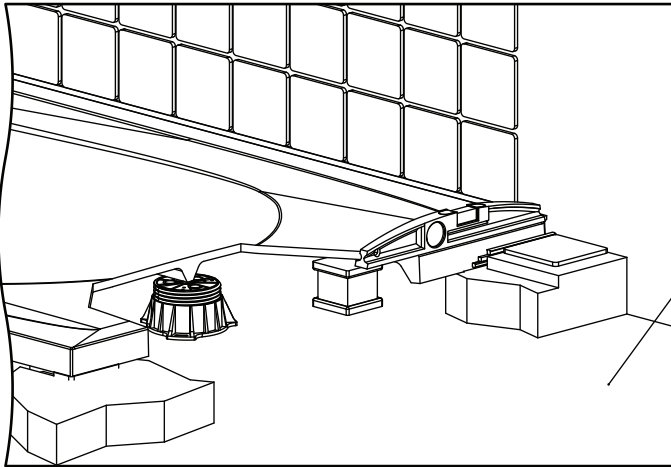

il suolo deve esser
rigido e non umido

Non sdraiarti
riscaldamento a
pavimento.

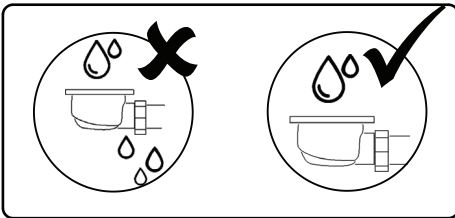

Posa diretta sul pavimento

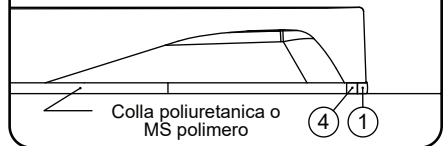

Colla poliuretantica o
MS polimero

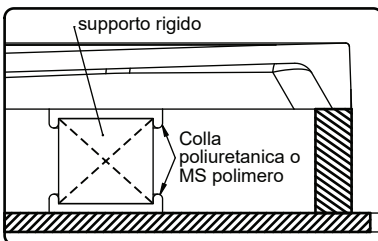

supporto rigido

Colla
poliuretantica o
MS polimero

Incassato

5 mm mini

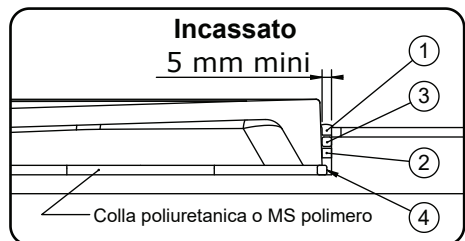

Colla poliuretantica o MS polimero

TIPI DI INSTALLAZIONE POSSIBILE

	90x90	100x100	100x80	100x90	120x80	120x90	120x100	140x80	140x90	140x100	160x80	160x90	160x100	180x80	180x80	180x80
X	90	100	100	100	120	120	120	140	140	140	160	160	160	180	180	180
Y	90	80	90	100	80	90	100	80	90	100	80	90	100	80	90	100
A	26,5	21,5	26,5	31,5	21,5	26,5	31,5	21,5	26,5	31,5	21,5	26,5	31,5	21,5	26,5	31,5
B	65	75	75	75	95	95	95	115	115	115	135	135	135	155	155	155

1. Posa su piedi regolabili con rivestimento piastrellato



Installazione di un supporto periferico essenziale

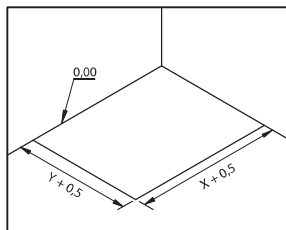
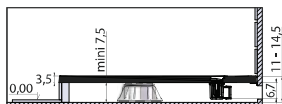

Preparazione per l'impianto

2. Posa su piastrelle

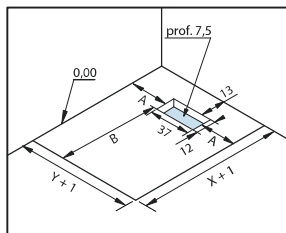
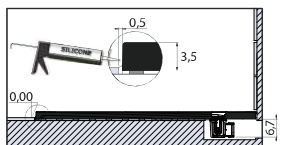
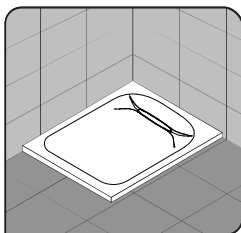

Preparazione per l'impianto

3. Incasso e posa con piedi regolabili



Installazione di un supporto periferico essenziale

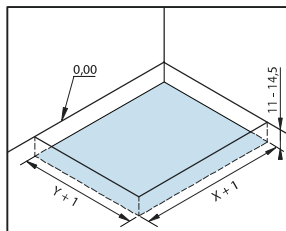
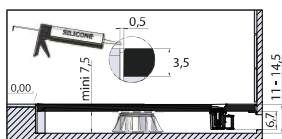

Preparazione per l'impianto

4. Incasso e posa senza piedi regolabili

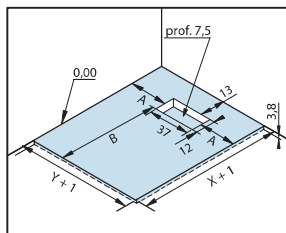
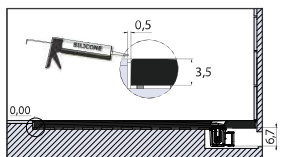
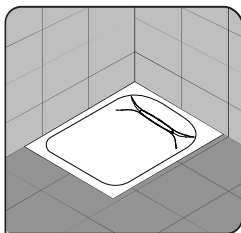

Preparazione per l'impianto

- FR**-Mise en place des plots de colle polyuréthane ou MS polymère
GB-Loading the plots glue polyurethane or MS polymer
ES-Ubicación de los puntos de pegamento poliuretano o polímero MS
PT-Localização dos pontos de cola de poliuretano ou polímero MS
IT-Posizione dei punti di colla poliuretanica o MS polimero
NL-Brenge de polyurethaan lijm of MS polymeer aan op de juiste plaats
DE-Bringen Sie den Polyurethan-/MS-Polymere-Kleber auf

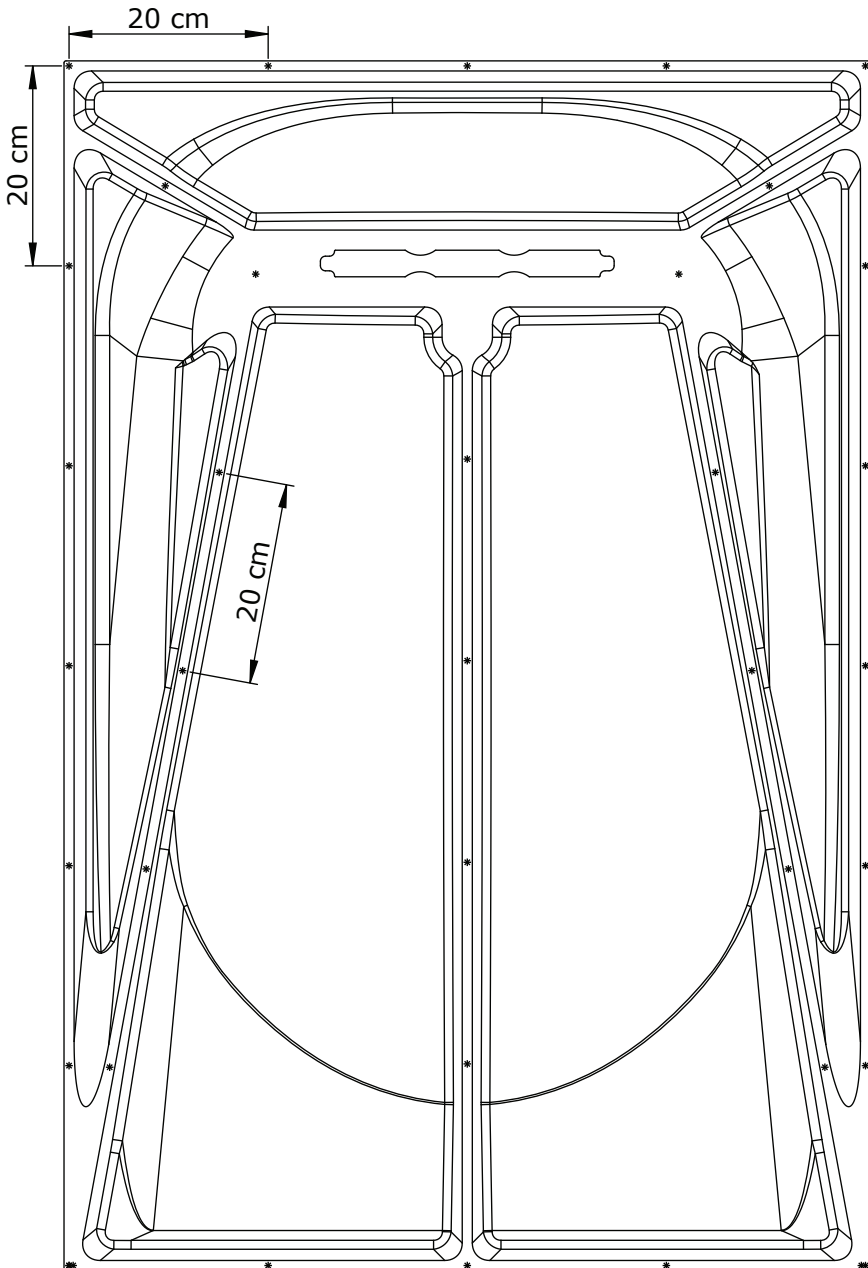

NL

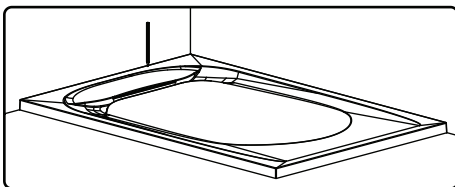

Markeer de positie van de afvoer en bepaal de plaats van de afvoer en de douchebak

- ① - Schimmelwerende siliconenkit met een lengte van minimaal 5mm
- ② - Siliconenkit voor een waterdichte afwerking, met schimmelwerende werking
- ③ - Steunelement van silicone pakking
- ④ - Siliconen ondersteuning

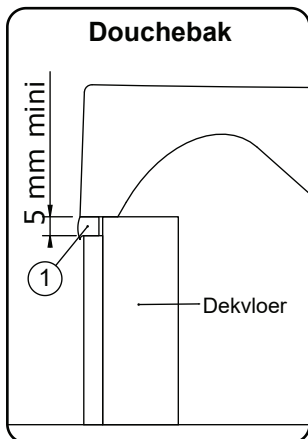
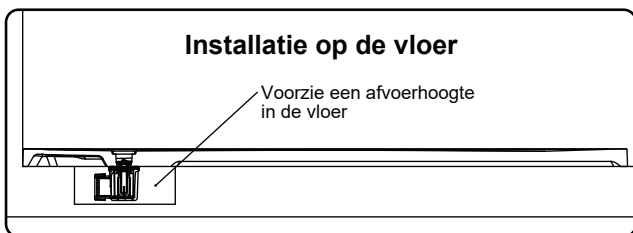
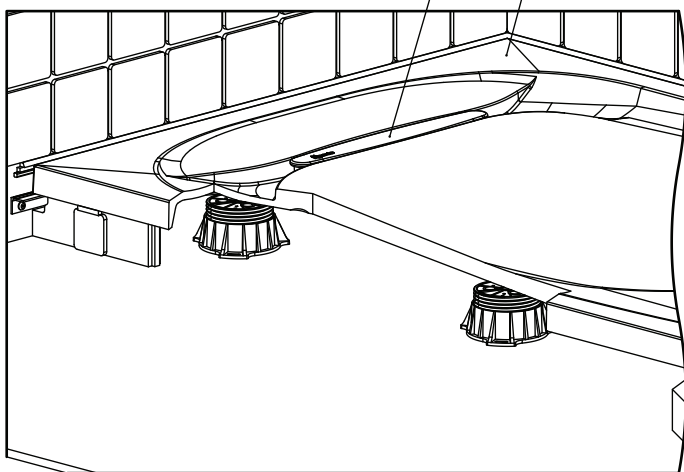
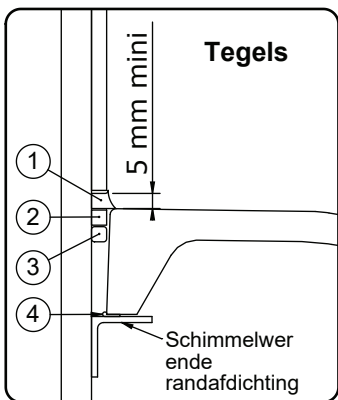



Bescherm de douchebak tijdens de werkzaamheden tegen brand, schokken, krassen etc.



Voor een optimaal gebruik is de montage van een terugslagklep noodzakelijk indien een ander sanitair toestel wordt aangesloten op dezelfde afvoer.

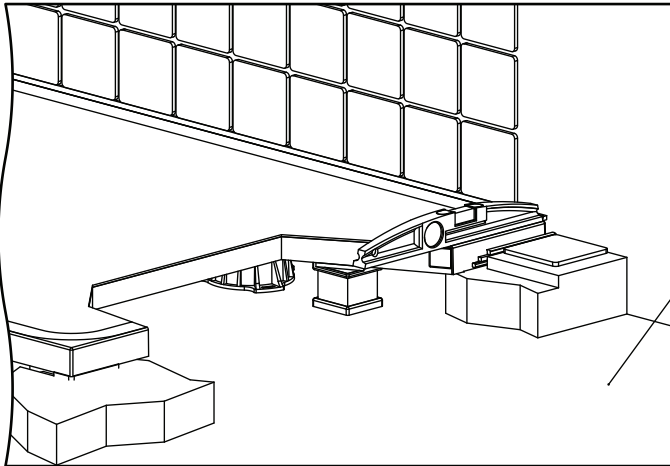

De ondergrond moet volkomen vlak en droog zijn

Niet op vloerverwarming plaatsen.

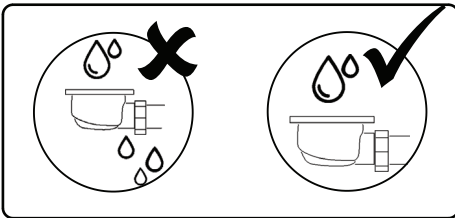

Direct op de grond

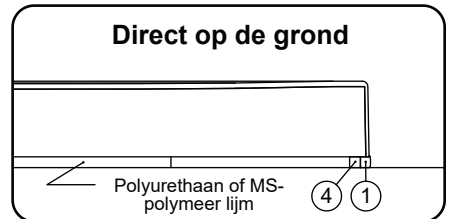

Installatie op de vloer

5 mm mini

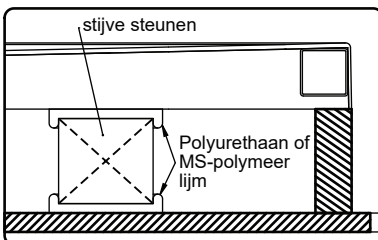
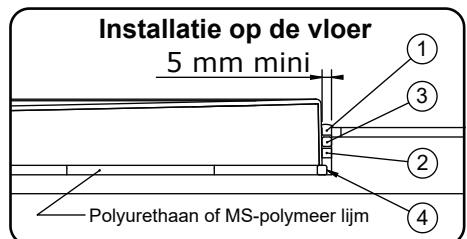

F

MOGELIJKE INSTALLATIES VOOR DOUCHEBAKKEN

	90x90	100x100	100x80	100x90	120x80	120x90	120x100	140x80	140x90	140x100	160x80	160x90	160x100	180x80	180x80	180x80
X	90	100	100	100	120	120	120	140	140	140	160	160	160	180	180	180
Y	90	80	90	100	80	90	100	80	90	100	80	90	100	80	90	100
A	26,5	21,5	26,5	31,5	21,5	26,5	31,5	21,5	26,5	31,5	21,5	26,5	31,5	21,5	26,5	31,5
B	65	75	75	75	95	95	95	115	115	115	135	135	135	155	155	155

1. Geplaatst op stelpoten en afgewerkt met betegeling



Aanbrengen van randversteving is noodzakelijk

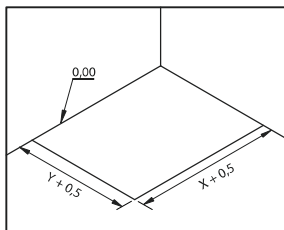
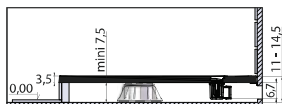

Vorbereitung montage

2. Geplaatst op tegelvloer

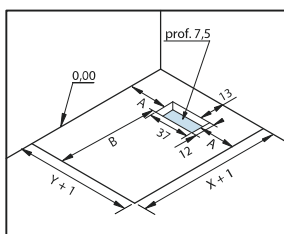
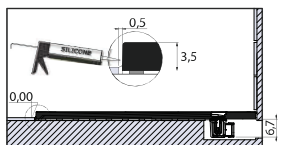
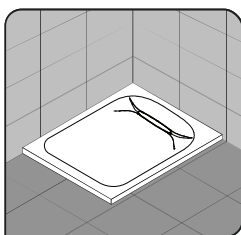

Vorbereitung montage

3. Ingebouwd en geplaatst op stelpoten



Aanbrengen van randversteving is noodzakelijk

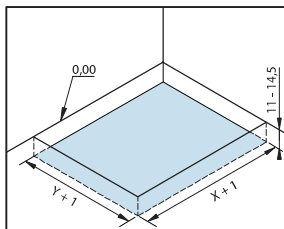
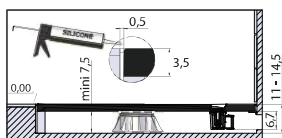

Vorbereitung montage

4. Ingebouwd en geplaatst zonder stelpoten

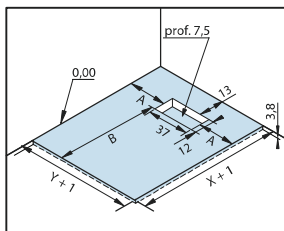
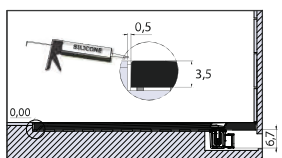
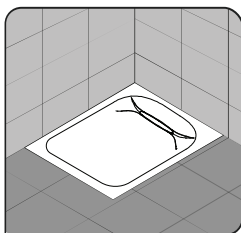

Vorbereitung montage

FR-Mise en place des plots de colle polyuréthane ou MS polymère

GB-Loading the plots glue polyurethane or MS polymer

ES-Ubicación de los puntos de pegamento poliuretano o polímero MS

PT-Localização dos pontos de cola de poliuretano ou polímero MS

IT-Posizione dei punti di colla poliuretanica o MS polimero

NL-Brenge de polyurethaan lijm of MS polymeer aan op de juiste plaats

DE-Bringen Sie den Polyurethan-/MS-Polymere-Kleber auf

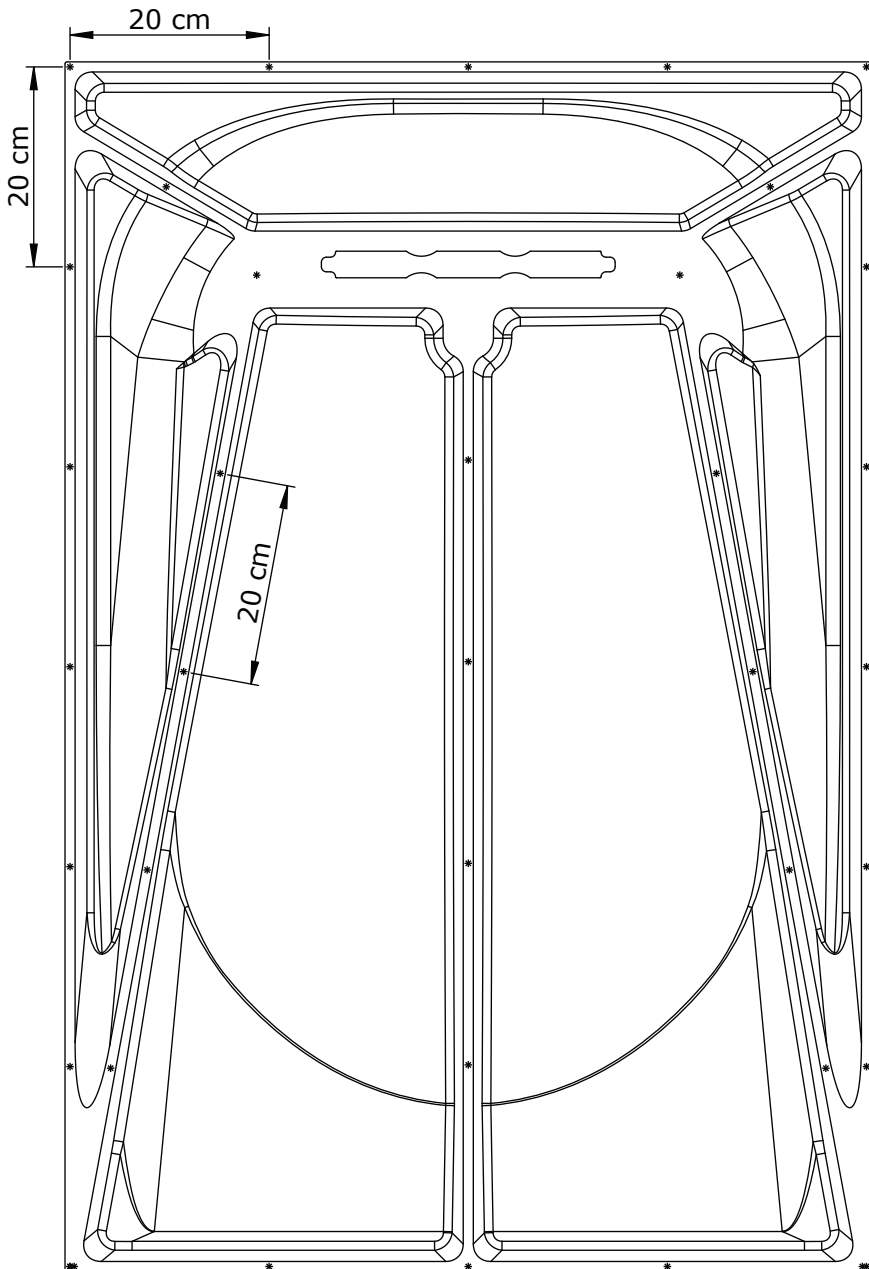

DE

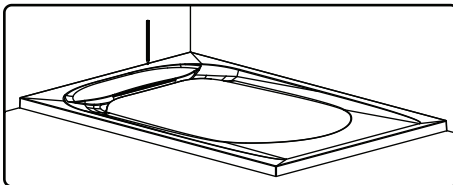

Die Position für den Ablauf anzeichnen und vormontieren

- ① - Pilzhemmendes Silikon mit einer Mindestbreite von 5mm
- ② - Weiches pilzhemmendes Dichtsilikon
- ③ - Stützelement der Silikondichtung
- ④ - Sanitärsilikon

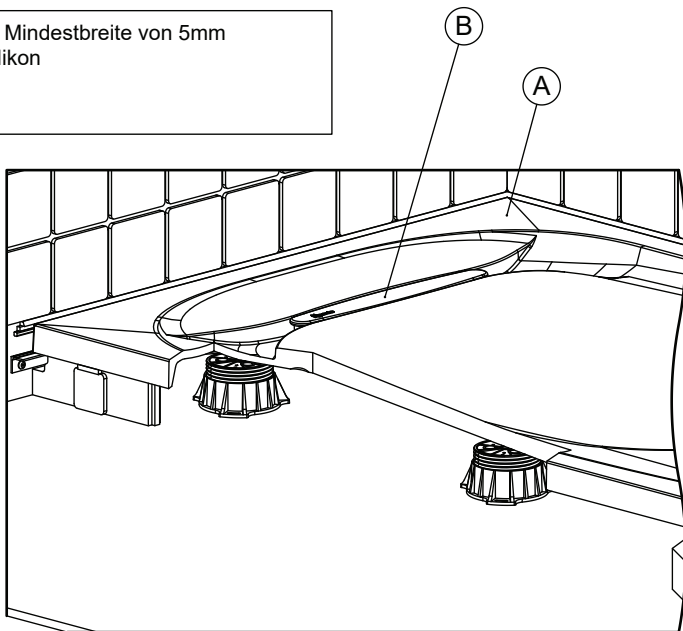
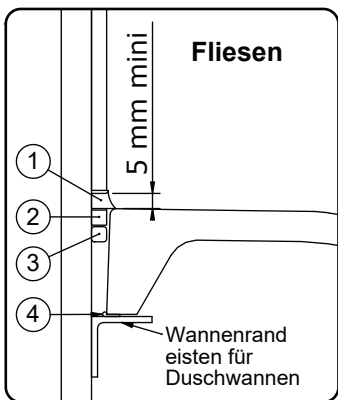

Es ist wichtig zu haben eine verrottungsfeste Unterstüztung auf alle Seiten des Empfängers.

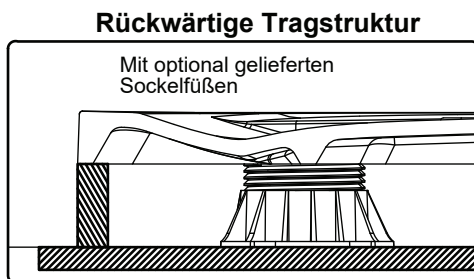
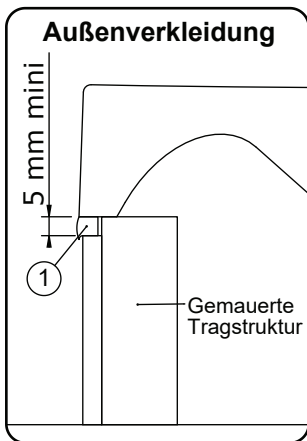
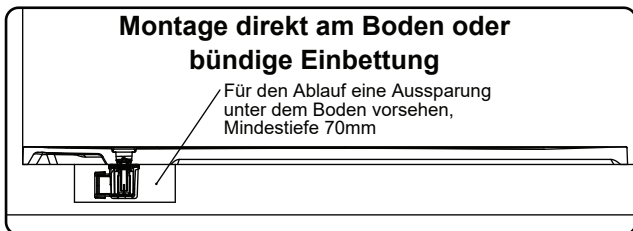

OD



Während der gesamten Dauer der Arbeiten ist die Duschtasse vor allen möglichen Beschädigungen zu schützen



Montage eines Anti-Vakuum-Ventils ist notwendig für die Verwendung optimal, wenn ein anderes Sanitärgerät ist mit der gleichen Evakuierung verbunden.

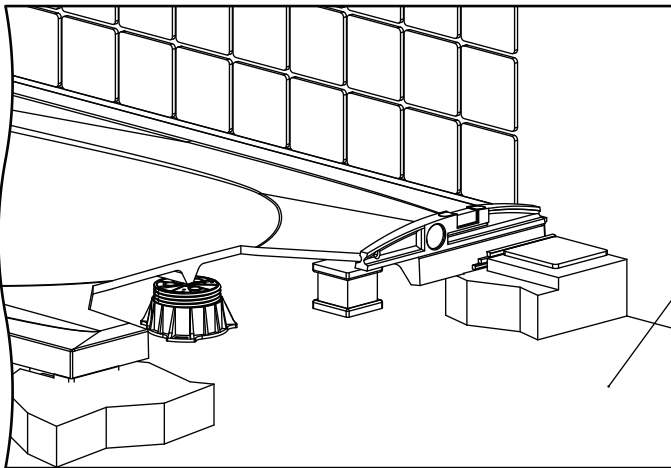

Ein fester und trockener Untergrund ist unabdingbar

Nicht auf Fußbodenheizung stellen.

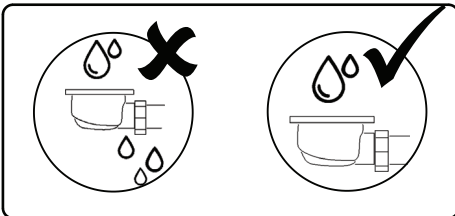

Montage direkt am Boden

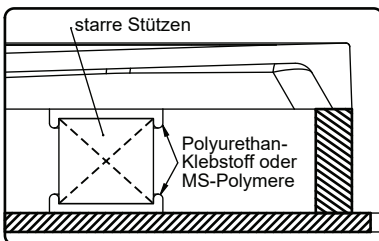
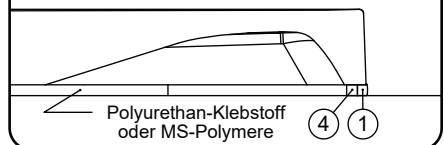

Inbouw op gelijke hoogte met de vloer

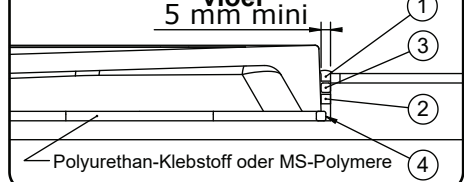

ER

MONTAGEMÖGLICHKEITEN FÜR

	90x90	100x100	100x80	100x90	120x80	120x90	120x100	140x80	140x90	140x100	160x80	160x90	160x100	180x80	180x80	180x80
X	90	100	100	100	120	120	120	140	140	140	160	160	160	180	180	180
Y	90	80	90	100	80	90	100	80	90	100	80	90	100	80	90	100
A	26,5	21,5	26,5	31,5	21,5	26,5	31,5	21,5	26,5	31,5	21,5	26,5	31,5	21,5	26,5	31,5
B	65	75	75	75	95	95	95	115	115	115	135	135	135	155	155	155

1. Montage auf einstellbarem Fliesensockel

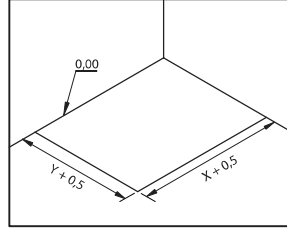
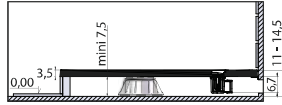

Vorbereitung der Montage

2. Auf Fliesenboden aufliegend

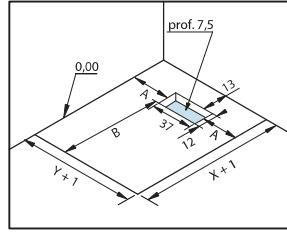
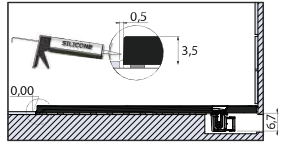
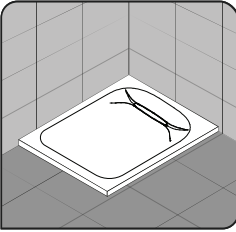

Vorbereitung der Montage

3. Eingebettet und mit einstellbarem Sockel

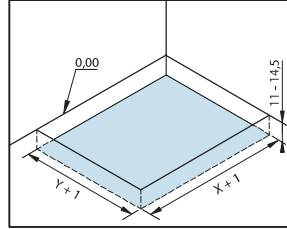
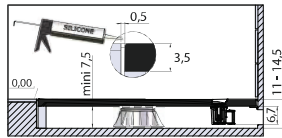
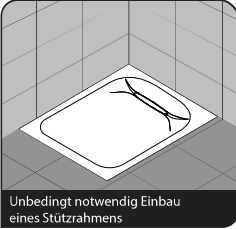

Vorbereitung der Montage

4. Eingebettet und ohne einstellbarem Sockel

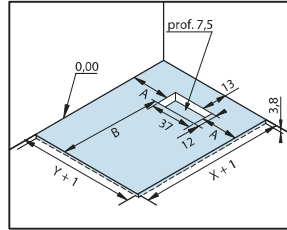
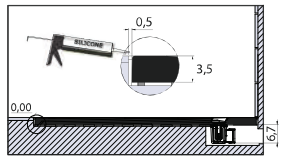
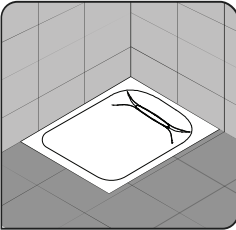

Vorbereitung der Montage

FR-Mise en place des plots de colle polyuréthane ou MS polymère

GB-Loading the plots glue polyurethane or MS polymer

ES-Ubicación de los puntos de pegamento poliuretano o polímero MS

PT-Localização dos pontos de cola de poliuretano ou polímero MS

IT-Posizione dei punti di colla poliuretanica o MS polimero

NL-Brenge de polyurethaan lijm of MS polymeer aan op de juiste plaats

DE-Bringen Sie den Polyurethan-/MS-Polymere-Kleber auf

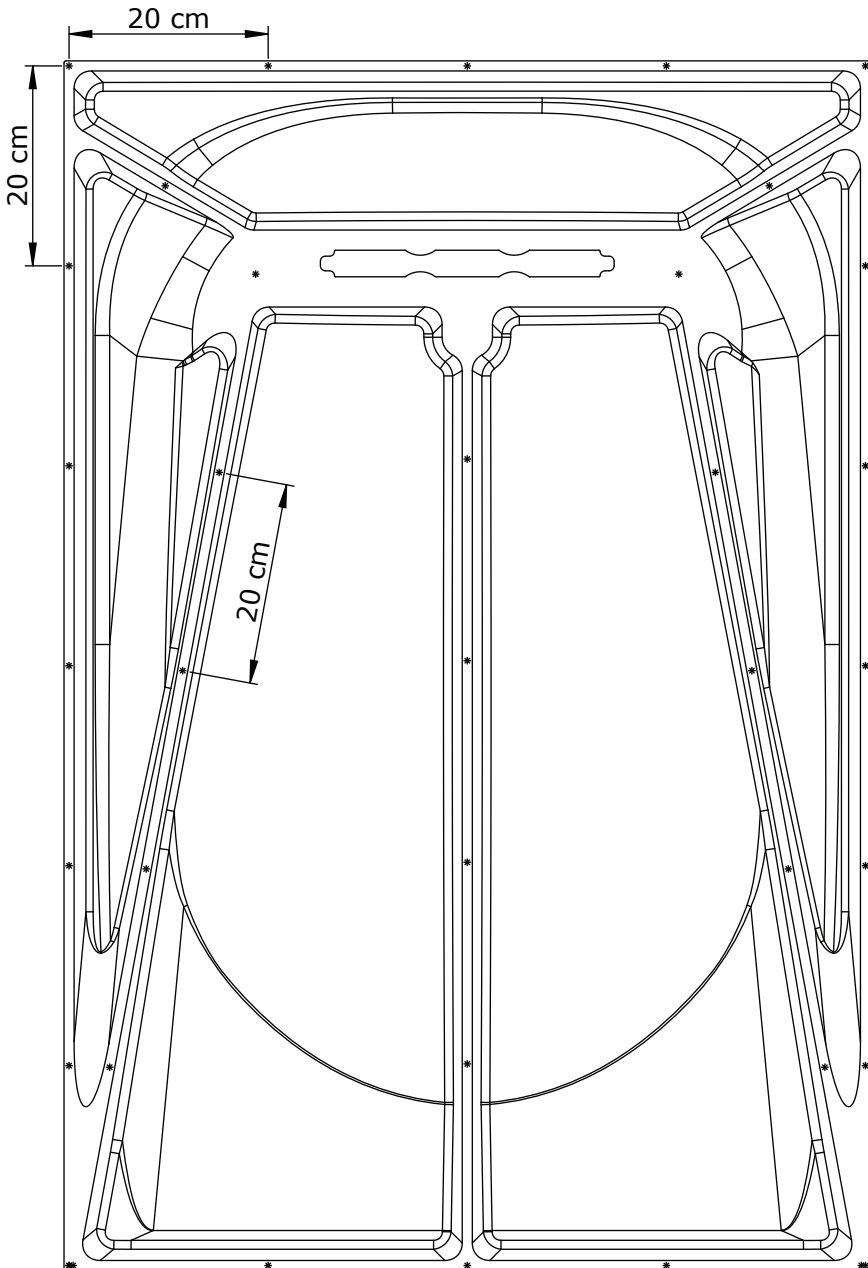

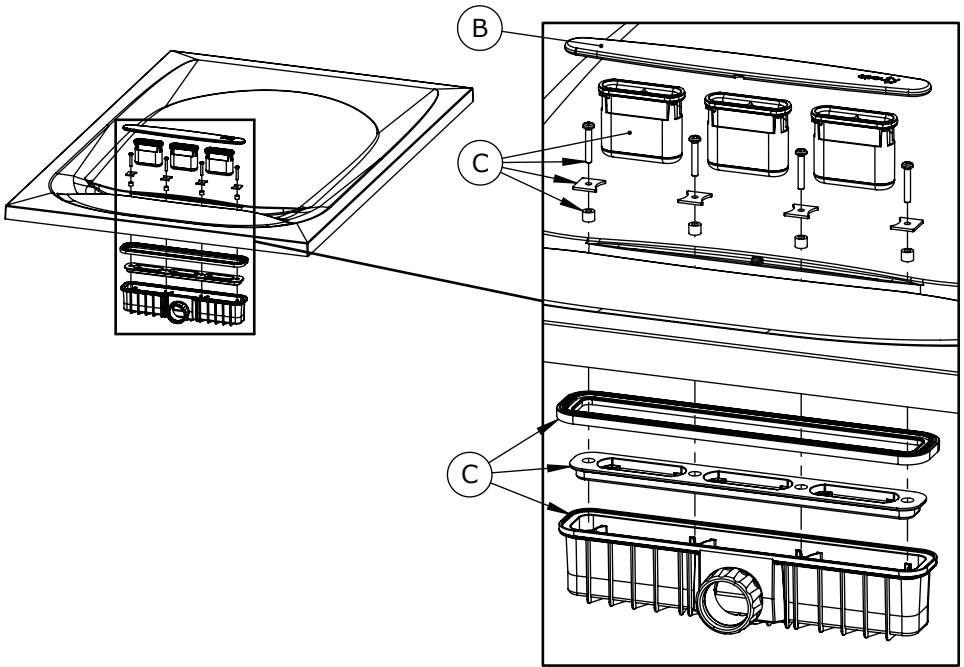

FR-Ou GB-Or ES-O
PT-Ou IT-O NL-Of.
DE-Oder.

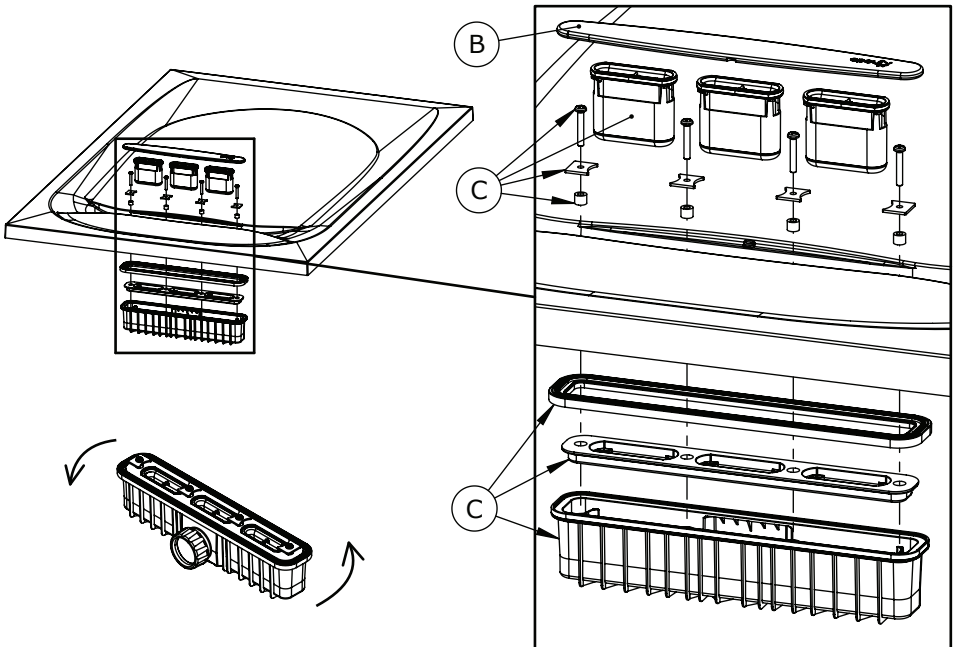



24h

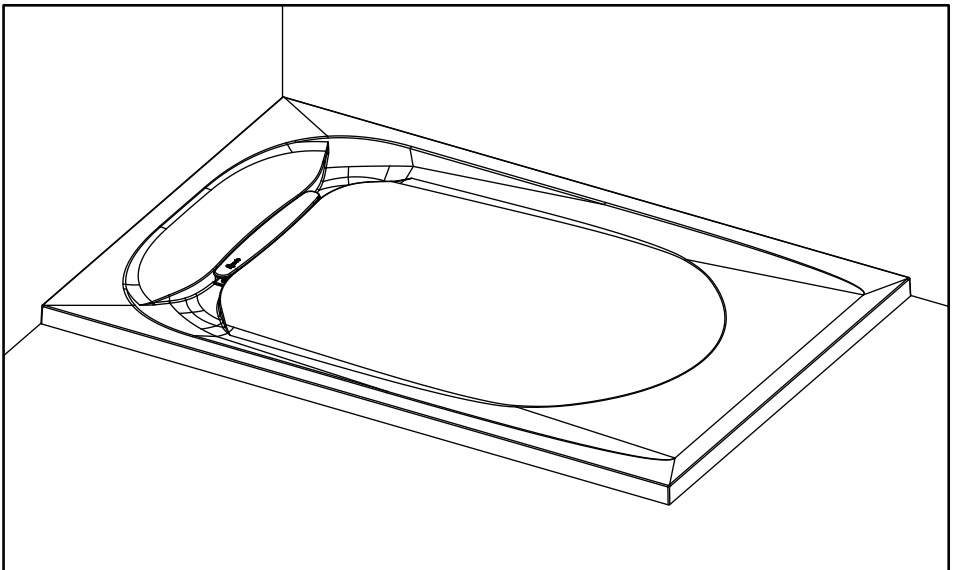



<p>FR</p> <p>Bon de garantie</p> <p>SCANNEZ MOI</p>  <p>http://tiny.cc/bon-de-garantie-fr</p>	<p>GB</p> <p>Guarantee</p> <p>SCAN ME</p>  <p>http://tiny.cc/bon-de-garantie-gb</p>
<p>DE</p> <p>Garantiekarte</p> <p>SCAN MICH</p>  <p>http://tiny.cc/bon-de-garantie-de</p>	<p>NL</p> <p>Garantievoorwaarden</p> <p>SCAN MIJ</p>  <p>http://tiny.cc/bon-de-garantie-nl</p>
<p>ES</p> <p>Garantía</p> <p>ESCANÉAME</p>  <p>http://tiny.cc/bon-de-garantie-es</p>	<p>IT</p> <p>Garanzia</p> <p>SCANSIONAMI</p>  <p>http://tiny.cc/bon-de-garantie-it</p>
<p>PT</p> <p>Garantia</p> <p>ESCANEEI-ME</p>  <p>http://tiny.cc/bon-de-garantie-pt</p>	<p>CH</p> <p>Garantiekarte</p> <p>SCAN MICH</p>  <p>http://tiny.cc/bon-de-garantie-ch</p>
<p>BE</p> <p>Garantievoorwaarden</p> <p>SCAN MIJ</p>  <p>http://tiny.cc/bon-de-garantie-be</p>	<p>AT</p> <p>Garantiekarte</p> <p>SCAN MICH</p>  <p>http://tiny.cc/bon-de-garantie-at</p>



Kinedo

FR

Conseils
d'entretien

SCANNEZ MOI



<http://tiny.cc/conseils-entretien-fr>

GB

Maintenance
instructions

SCAN ME



<http://tiny.cc/conseils-entretien-gb>

DE

Wartungstipps

SCAN MICH



<http://tiny.cc/conseils-entretien-de>

NL

Onderhoudstips

SCAN MIJ



<http://tiny.cc/conseils-entretien-nl>

ES

Consejos de
mantenimiento

ESCANÉAME



<http://tiny.cc/conseils-entretien-es>

IT

Consigli per la
manutenzione

SCANSIONAMI



<http://tiny.cc/conseils-entretien-it>

PT

Dicas de
manutenção

ESCANIEI-ME



<http://tiny.cc/conseils-entretien-pt>

CH

Wartungstipps

SCAN MICH



<http://tiny.cc/conseils-entretien-ch>

BE

Onderhoudstips

SCAN MIJ



<http://tiny.cc/conseils-entretien-be>

AT

Wartungstipps

SCAN MICH



<http://tiny.cc/conseils-entretien-at>



SERVICE APRÈS-VENTE AFTER-SALES SERVICE

FRANCE

+33 (0)2 40 21 29 45

UK

+44 (0)20 8842 0033

IRELAND

+353 04697 33102

DEUTSCHLAND

+49 (0) 6074 / 30928 0

ITALIA

+39 02 30559420

ÖSTEREICH

+43 1 710 60 70

SUISSE/SCHWEIZ

+41 (0)32 631 04 74

ESPAÑA

+34 93 544 60 76

NEDERLAND

+31 475 487 100

BELGIQUE/BELGIË

+31 475 487 100

РОССИЯ

+7 495 258-29-51

PORTUGAL

+351 219 112 785



AQUAPRODUCTION, Site industriel,
F - 44680 Chaumes-en-Retz

24

EN 14527 - CL2

Aptitude au nettoyage :

satisfaisant

Durabilité :

satisfaisant