

FR-IMPORTANT

Nettoyez à l'eau savonneuse avant application
d'un cordon de silicone

GB-IMPORTANT

Clean with soapy water and soap before
applying a silicone bead

ES-IMPORTANTE

Limpiar con agua y jabón antes de aplicar un
cordón de silicona

PT-IMPORTANTE

Limpe com água e sabão antes de aplicar um
cordão de silicone

IT-IMPORTANTE

Pulire con acqua saponata prima di passare il
cordone di silicone

NL-BELANGRIJK

Voordat een siliconenlaagje wordt aangebracht,
eerst reinigen met zeepsop

DE-WICHTIG

Vor dem Auftragen von Silikon mit Seifenwasser
reinigen

A

x1

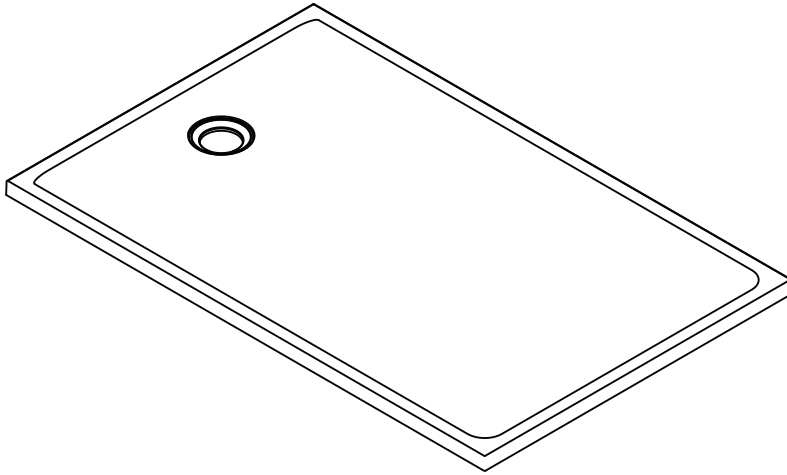

100x70	REM896	120x100	REM903				
100x80	REM897	140x70	REM904	160x80	REM909		
100x90	REM898	140x80	REM905	160x90	REM910	180x70	REM913
120x70	REM900	140x90	REM906	160x100	REM911	180x80	REM914
120x80	REM901	140x100	REM907	170x80	REM918	180x90	REM915
120x90	REM902	160x70	REM908	170x90	REM930	180x100	REM916

B

x1

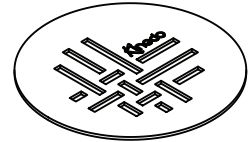

TOL198

C

x1

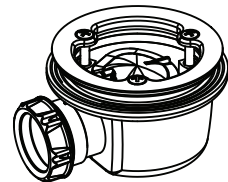

BOND33

80x80	REM894
90x90	REM895
100x100	REM899

FR - Les quantités données sont les quantités utiles au montage. les sachets fournis contiennent des pièces supplémentaires.

GB - The quantities given are what are required for the installation. There may be some surplus in the package provide.

ES - Las cantidades indicadas son las cantidades necesarias para el montaje. Las bolsitas incluidas contienen piezas suplementarias.

PT - A quantidade indicada é a quantidade necessária para a montagem. As bolsas incluem peças adicionais.

IT - Le quantità fornite sono le quantità necessarie al montaggio. I sacchetti forniti contengono pezzi supplementari.

NL - De aangegeven aantallen zijn bestemd voor de montage. De bijgeleverde zakjes bevatten extra onderdelen

DE - Die Mengenangaben beziehen sich auf die für die Montage benötigten Teile. Es kann eine gewisse Überzahl an Teilen in der Packung vorhanden sein.

FR-Matériel nécessaire GB-Tools required
ES-Equipamiento necesario PT-Equipamento necessário
IT-Materiale necessario NL-Benodigd gereedschap DE-Benötigte Werkzeuge

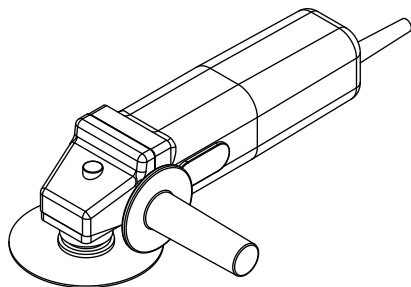
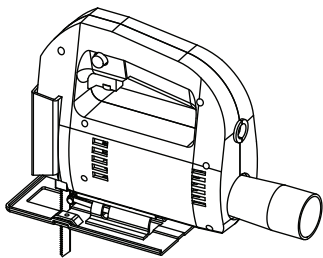
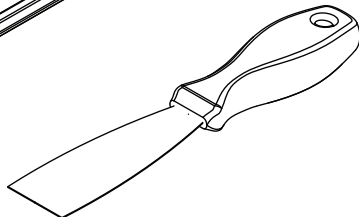
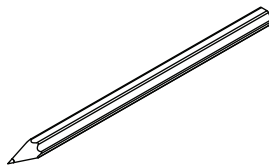
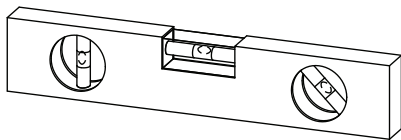

- FR**-Scie sauteuse avec lame multi-matériaux
GB-Jigsaw with multi-material blade
ES-Sierra de calar con hoja multimaterial
PT-Serra vertical com lâmina multimaterial
IT-Seghetto alternativo con lama multimateriale
NL-Decoupeerzaag met multimateriaalblad
DE-Stichsäge mit Multimaterial-Blatt

- FR**-Meuleuse **GB**-Grinder
ES-Amoladora **PT**-Moedor
IT-Mola **NL**-Slijpmachine
DE-Winkelschleifer

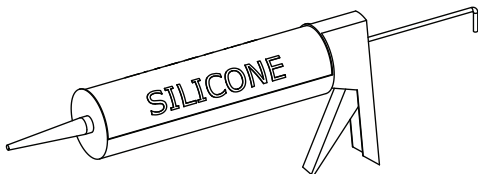

- FR**-Utiliser un silicone adapté au matériau de chaque support (faïence, acrylique, etc.)
GB-Use a silicone sealant that is suitable for the surrounding materials (ceramic, acrylic, etc.)
ES-Utilizar silicona adecuada para el material de cada soporte (loza, acrílico, etc.)
PT-Use um silicone adequado para o material de cada suporte (faiança, acrílico, etc.)
IT-Utilizzare silicone adatto per il materiale di ogni supporto (porcellana, acrilico, ecc.)
NL-Gebruik een silicone die geschikt is voor het materiaal van elke steun (keramiek, acryl, enz.)
DE-Verwenden Sie ein geeignetes Silikon für das Material der Duschwanne (Steingut, Acryl, etc.)

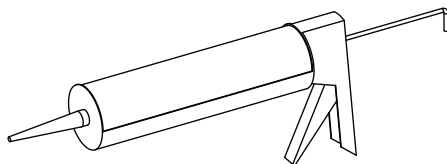

- FR**-Colle POLYURETHANE ou MS POLYMERE
GB-POLYURETHANE or MS POLYMER glue
ES-Adhesivo POLIURETANO o MS POLYMERE
PT-Cola POLYURETHANE ou MS POLYMERE
IT-Colla POLIURETANICA ou MS POLYMERE
NL-POLYURETHAAN- of MS-POLYMEERLIJM
DE-POLYURETHAN oder MS POLYMER KLEBER



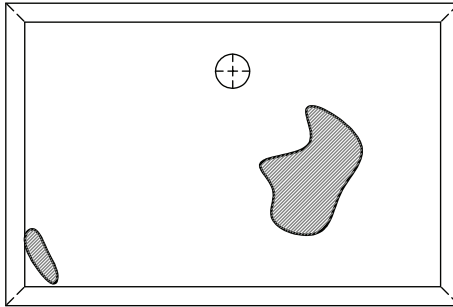

FR-D'éventuelles irrégularités de surface sur le dessous de votre receveur n'empêchent pas une installation conforme aux préconisations de pose. La colle (type polyuréthane ou MS polymère) comblera facilement ces manques lors du collage.

GB-Any surface irregularities on the underside of the shower tray have no influence on the installation according to the installation recommendations. The adhesive (polyurethane or MS polymer) compensates for these unevenness when bonding the feet off without any problems.

ES-Posibles irregularidades de la superficie en la parte inferior del receptor no impida la instalación de acuerdo con las recomendaciones de instalación. El adhesivo (tipo poliuretano o polímero MS) rellenará fácilmente estos huecos al pegar los pies.

PT-Possíveis irregularidades da superfície na parte inferior do receptor não são impedir a instalação de acordo com as recomendações de instalação. O adesivo (tipo poliuretano ou polímero MS) preencherá facilmente essas lacunas ao bater os pés.

IT-Eventuali irregolarità della superficie nella parte sotto della doccia non impediscono l'installazione in base alle raccomandazioni di montaggio. La colla (tipo poliuretano o MS polimero) riempirà facilmente queste lacuna quando si incollano i piedini.

NL-Eventuele onregelmatigheden in de vlakke onderzijde van uw douchebak vormen geen belemmering voor een installatie conform aan de gestelde richtlijnen. De lijm (type polyurethaan of MS-polymeer) vult eventuele openingen makkelijk op tijdens het lijmen.

DE-Eventuelle Unregelmäßigkeiten der Oberfläche an der Unterseite Ihrer Duschwanne haben keinen Einfluss auf die Installation gemäß den Einbauempfehlungen. Der Klebstoff (Typs Polyurethan oder MS-Polymer) gleicht diese Unebenheiten beim Verkleben problemlos aus.



FR-Aspirer le dessous de votre receveur avant la pose

GB-Vacuum the bottom of the shower tray before installation

ES-Aspirar la parte inferior de su plato de ducha antes de instalarlo

PT-Aspire o fundo da sua base de chuveiro antes de instalá-la

IT-Aspirare la parte sottostante del piatto doccia prima dell'installazione

NL-Stofzuig de bodem van de douchebak voor de installatie

DE-Saugen Sie den Boden der Duschwanne vor der Installation ab



FR-Découpe optionnelle du receveur **GB**-Optional cutting of the receiver
ES-Recorte opcional **PT**-Corte opcional da placa
IT-Taglio opzionale del piatto **NL**-Bijsnijden van de douchebak, optioneel
DE-Sonder cutting der duschwanne

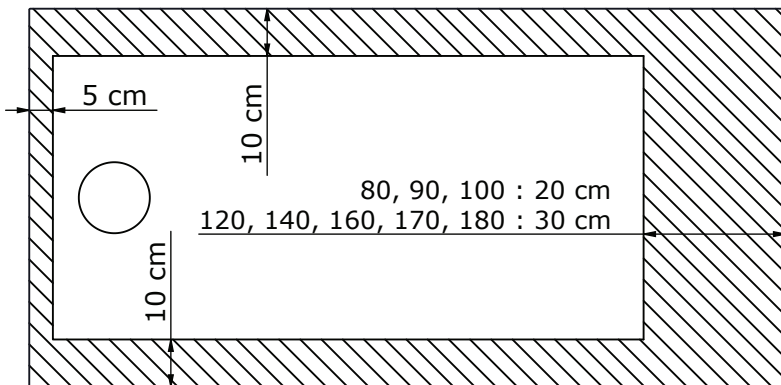
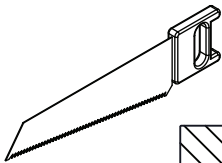

FR-Zone maxi découpable (Découpe possible sur maximum 3 des 4 côtés du receveur)
GB-Maxi cuttable area (Cutout possible on a maximum of 3 of the 4 sides of the tray)
ES-Área de corte maxi (corte posible en un máximo de 3 de los 4 lados de la bandeja)
PT-Maxi área de corte (corte possível em no máximo 3 dos 4 lados da bandeja)
IT-Maxi superficie tagliabile (Ritaglio possibile su un massimo di 3 dei 4 lati del vassoio)
NL-Maximaal snijgebied (maximaal 3 van de 4 zijden van de lade kunnen worden gesneden)
DE-Maximaler Schneidbereich (Ausschnitt auf maximal 3 der 4 Seiten des Trays möglich)

FR-Si vous avez découpé votre receveur, vous devez appliquer une couche de colle polyuréthane ou MS polymère à l'aide d'une spatule sur la surface coupée, bien aspirer les poussières résiduelles sur la tranche du receveur avant d'appliquer le mastic/colle.

GB-If you have cut your receiver, you must apply a layer of polyurethane or MS polymer glue with a spatula on the cut surface, vacuum up any residual dust on the edge of the receiver before applying the mastic/glue.

ES-Si ha recortado el plato, debe aplicar una capa de pegamento poliuretano o polímero MS en la superficie recortada. Puede ayudarse de una espátula, Aspirar el polvo residual en el lateral del plato antes de aplicar el pegamento.

PT-Se você recortou a placa, deve aplicar uma camada de poliuretano ou cola de polímero MS na superfície recortada. Você pode se ajudar com uma espátula, Aspire o pó residual na lateral da placa antes de aplicar a cola.

IT-Se avete tagliato il vostro piatto, dovete applicare della colla poliuretanicca o MS polimero con l'aiuto di una spatola sul lato tagliato, Aspirare accuratamente la polvere residua sul bordo del piatto prima di applicare il sigillante/adesivo.

NL-Wanneer u uw douchebak heeft bijgesneden dient u met een spatel een laag polyuretaan lijm of MS polymeer op de rand het afgesneden deel aan te brengen, verwijder de overgebleven stoffen kunststofdeeltjes op de douchebak voordat de lijm wordt aangebracht.

DE-Wenn Sie Ihre Duschanne schneiden müssen Sie ein Polyurethan-Klebstoff-Schicht oder MSPolymer mit einem Spatel über den Schnitt zutreffen Oberfläche, den restlichen Staub vor dem Auftragen des Dichtmittels / Klebers gründlich absaugen.



FR-Nombre de pieds **GB**-Feet quantity **ES**-Cantidad de pies
PT-Quantidade de pés **IT**-Quantità di piedin
NL-Hoeveelheid voeten **DE**-Zahl der FüÙe

80x80 5	90x90 6	100x100 6	100x70 6	100x80 6	100x90 6	120x70 8	120x80 8
120x90 8	120x100 8	140x70 9	140x80 9	140x90 9	140x100 9	160x70 12	160x80 12
160x90 12	160x100 12	170x80 12	170x90 12	180x70 12	180x80 12	180x90 12	180x100 12

FR-La distance bord à bord entre deux pieds ne doit pas être de plus de 25 cm.

GB-The distance from the edge of the shower tray to the edge of a peripheral support should be no more than 25 cm.

ES-La distancia entre cada pie no debe superar los 25 cm.

PT-A distância entre dois pés não deve exeder 25 cm.

IT-Il bordo di distanza dal bordo tra due piedi non dovrebbe essere superiore a 25 cm.

NL-De afstand tussen twee stelpoten mag niet meer dan 25 cm bedragen.

DE-Der Abstand zwischen zwei verstellbaren FüÙen darf 25 cm nicht überschreiten.



http://tiny.cc/notice_pieds_ksf_nova

FR

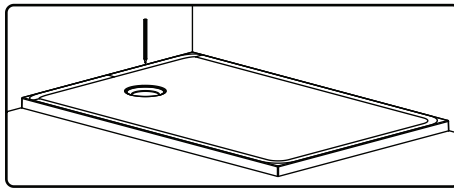

Tracer la position de la bonde et réaliser un montage à blanc de la bonde et du receveur

- ① - silicone de finition traité antifongique de 5mm de largeur minimum
- ② - silicone d'étanchéité souple traité antifongique
- ③ - élément de soutien du joint silicone
- ④ - silicone d'appui

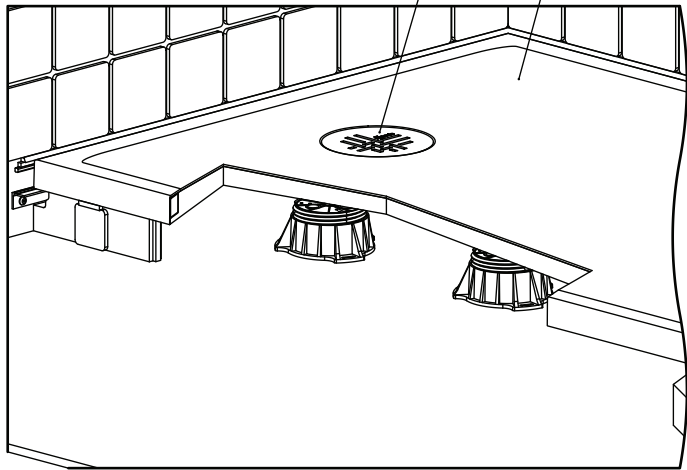
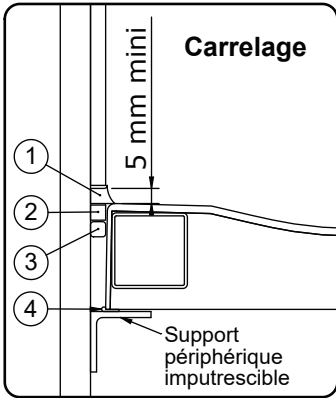

Il est indispensable d'avoir un support imputrescible sur tous les côtés du receveur.

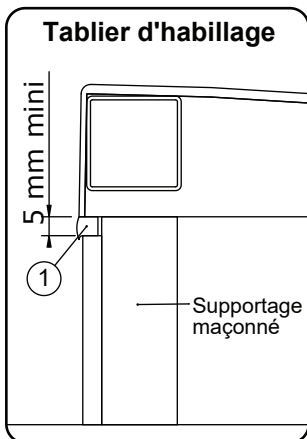
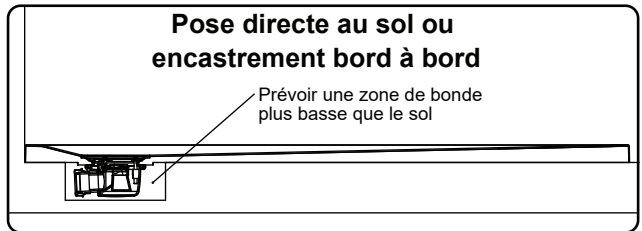

Supportage du fond

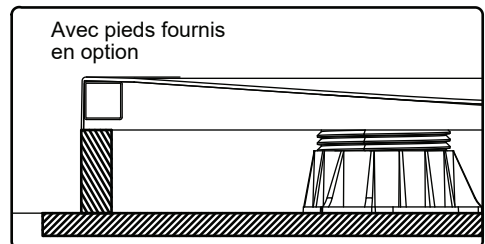



Pendant toute la durée des travaux, protéger le receveur contre toute agression : brûlures, chocs, rayures, décapants...



Le montage d'une *soupape anti-vide* est nécessaire pour une utilisation optimale si un autre appareil sanitaire est raccordé sur la même évacuation.

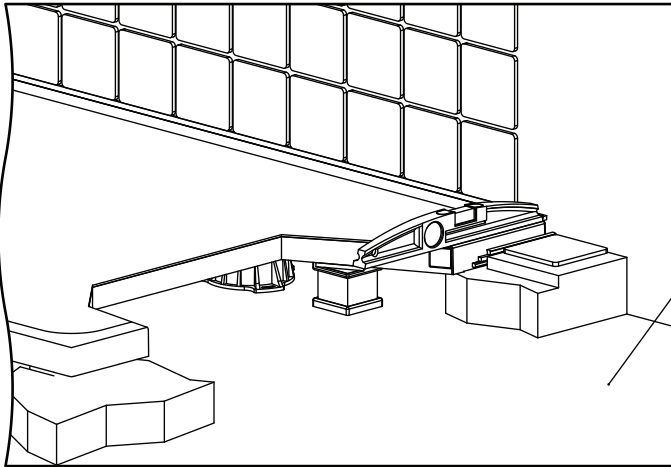

Sol rigide et non humide indispensable.

Ne pas poser sur plancher chauffant.

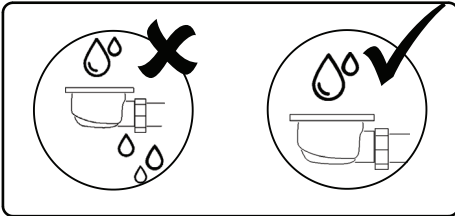

Pose directe au sol

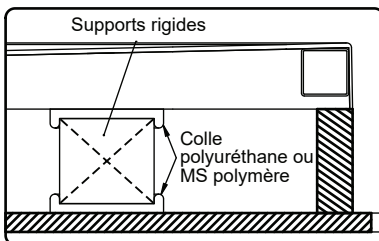
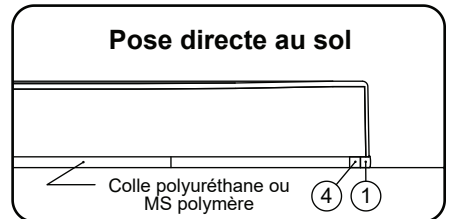

Encastrement bord à bord

5 mm mini

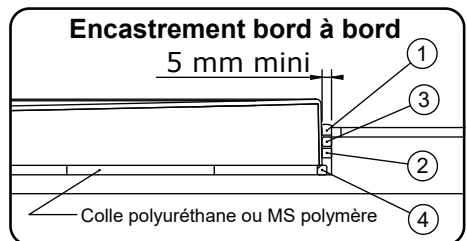

TYPES D'INSTALLATION

1. Posé sur pieds réglables avec habillage carrelé

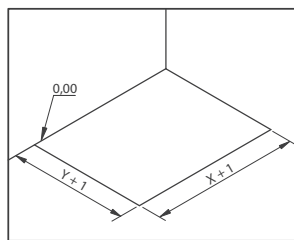
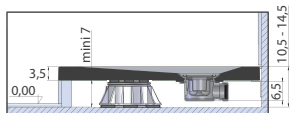

Préparation de l'implantation

2. Posé en butée contre le carrelage

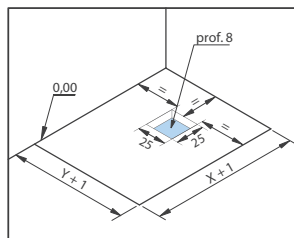
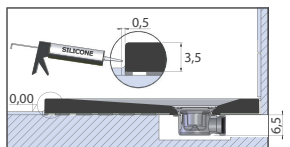
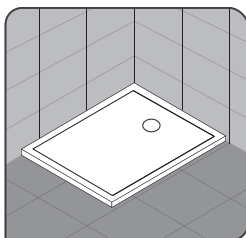

Préparation de l'implantation

3. Encastré et posé sur pieds réglables

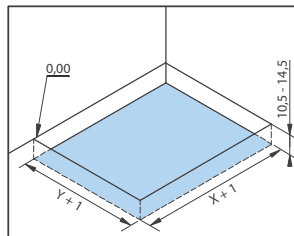
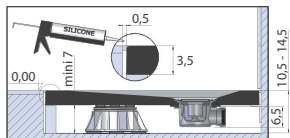

Préparation de l'implantation

4. Encastré et posé sans pieds réglables

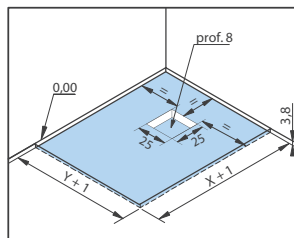
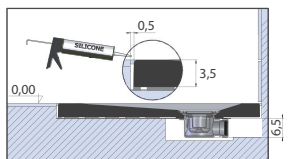
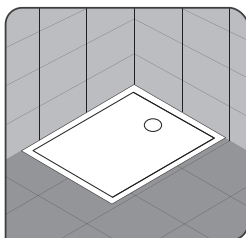

Préparation de l'implantation

X	Y
80	80
90	90
100	100
100	70
100	80
100	90
120	70
120	80
120	90
120	100
140	70
140	80
140	90
140	100
160	70
160	80
160	90
160	100
170	70
170	80
170	90
180	70
180	80
180	90
180	100

FR-MISE EN PLACE DES PLOTS DE COLLE POLYURETHANE OU MS POLYMERE
GB-PLACEMENT OF POLYURETHANE OR MS POLYMER GLUE PLUGS
ES-COLOCACIÓN DE PLACAS DE PEGAMENTO DE POLIURETANO O MS POLYMER
PT-POSICÃO DOS PONTOS DE COLA DE POLIURETANO OU POLÍMERO MS
IT-POSIZIONAMENTO PIASTRE DI COLLA POLIURETANO O MS POLIMERO
NL-BRENG DE POLYURETAAN LIJM OF MS POLYMEERAAN OP DE JUISTE PLAATS
DE-BRINGEN SIE DEN POLYURETHAN-/MS-POLYMERE-KLEBER AUF

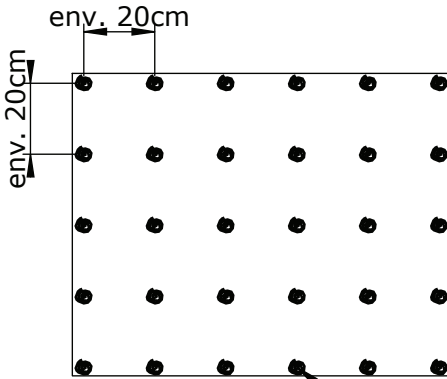

FR-Exemple receveur **100x80**

GB-Example of a **100 x 80** shower tray

ES-Ejemplo de plato de ducha **100 x 80**

PT-Exemplo de base de duche **100 x 80**

IT-Esempio di piatto doccia **100 x 80**

NL-Voorbeeld met douchebak **100 x 80**

DE-Beispiel mit Duschwanne **100 x 80**

FR-Colle Polyuréthane ou MS Polymère

GB-Polyurethane adhesive or MS polymer

ES-Pegamento poliuretano o polimero

PT-Cola de poliuretano ou polímero MS

IT-Colla poliuretanicca o MS polimero

NL-Polyurethaan of MS-polymeer lijm

DE-Polyurethan-kmebstoff oder MS-polymere

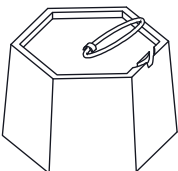
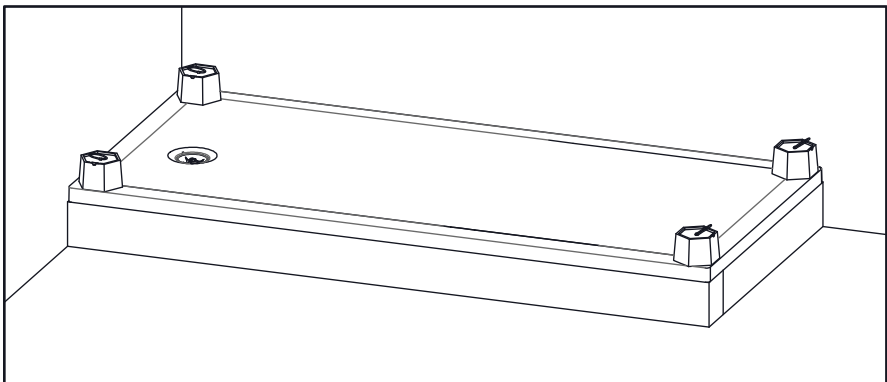

= 15Kg



24H

GB

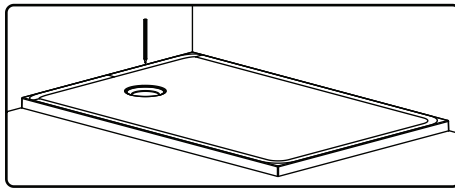

Mark the position of the plug and perform a
White mounting the bung and recipient

- ① - finishing antifungal treated silicone minimum width of 5mm
- ② - flexible sealing silicone treated antifungal
- ③ - support Element silicone seal
- ④ - silicone support

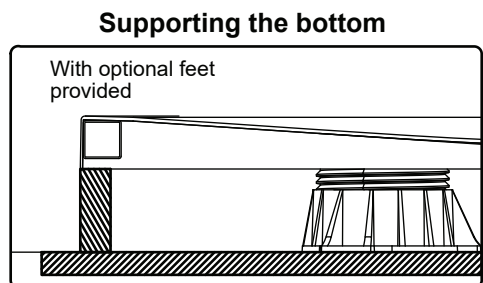
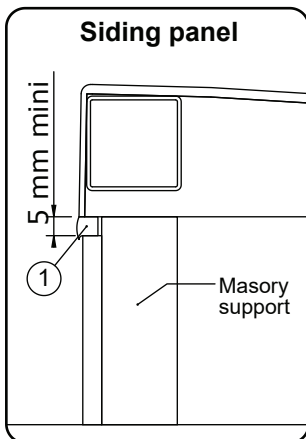
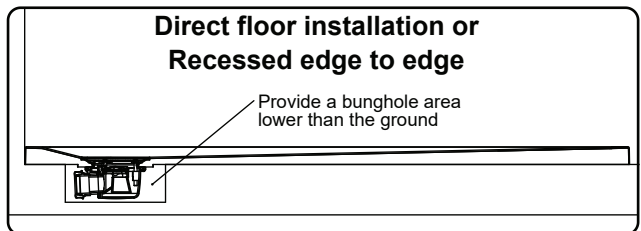
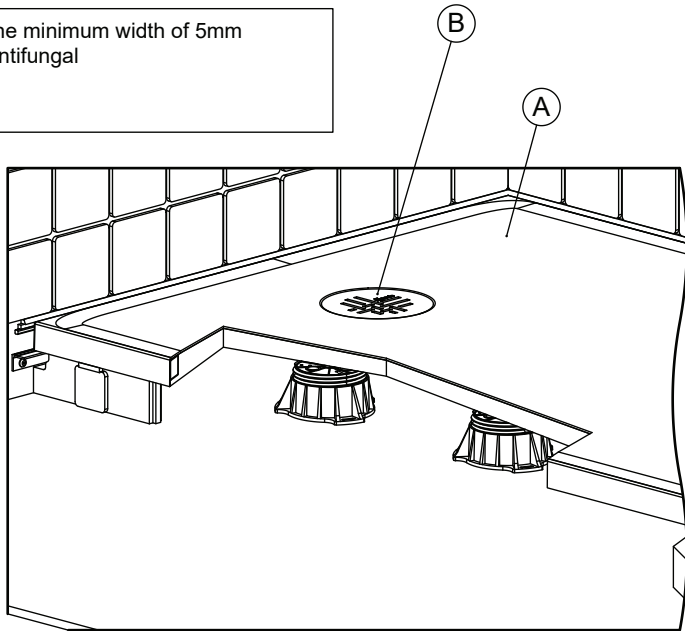
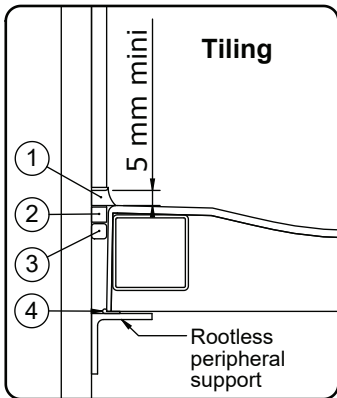

O



The installation of an anti-evacuation valve is necessary for optimum use if another sanitary appliance is connected to the same evacuation

Throughout the duration of the work, protect the recipient against any aggression : burns, shock, scratches, strippers...

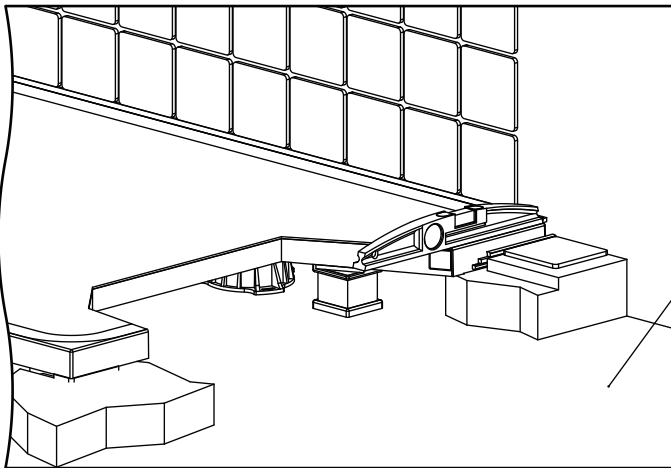

The underlying floor must absolutely be rigid and dry / Ensure a solid dry surface

Do not place on underfloor heating.

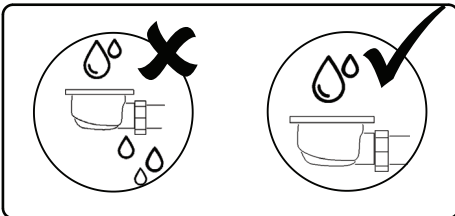

Direct floor installation

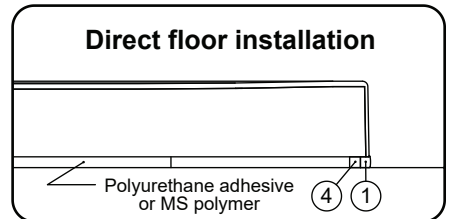

Recessed edge to edge

5 mm mini

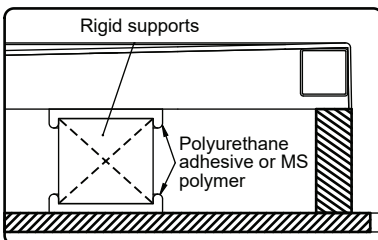
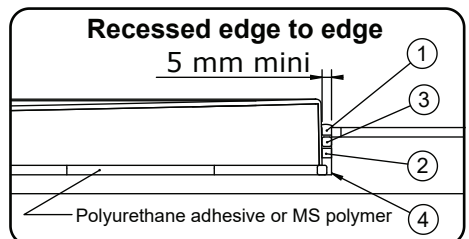

POSSIBLE TYPES OF INSTALLATIONS

1. Mounted on adjustable legs with tiled cladding

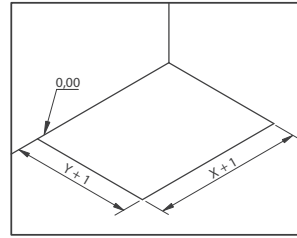
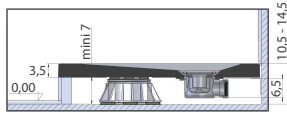
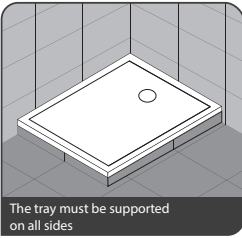

Preparation of the implementation

2. Installed on tiles

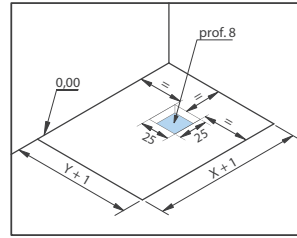
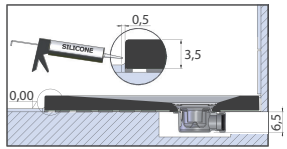
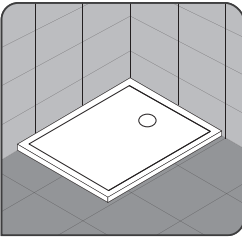

Preparation of the implementation

3. Built-in and placed on adjustable legs

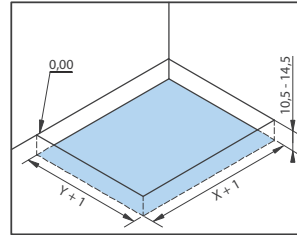
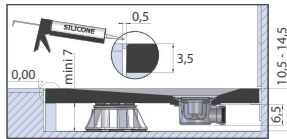

Preparation of the implementation

4. Built-in and installed without adjustable feet

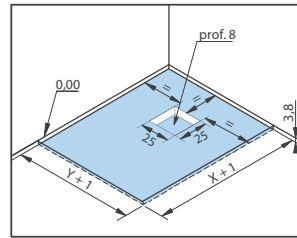
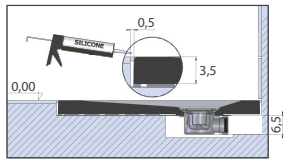
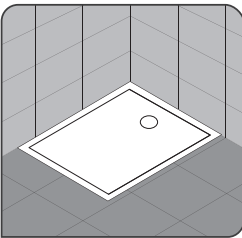

Preparation of the implementation

X	Y
80	80
90	90
100	100
100	70
100	80
100	90
120	70
120	80
120	90
120	100
140	70
140	80
140	90
140	100
160	70
160	80
160	90
160	100
170	70
170	80
170	90
180	70
180	80
180	90
180	100

FR-MISE EN PLACE DES PLOTS DE COLLE POLYURETHANE OU MS POLYMERE
GB-PLACEMENT OF POLYURETHANE OR MS POLYMER GLUE PLUGS
ES-COLOCACIÓN DE PLACAS DE PEGAMENTO DE POLIURETANO O MS POLYMER
PT-POSICÃO DOS PONTOS DE COLA DE POLIURETANO OU POLÍMERO MS
IT-POSIZIONAMENTO PIASTRE DI COLLA POLIURETANO O MS POLIMERO
NL-BRENG DE POLYURETAAN LIJM OF MS POLYMEERAAN OP DE JUISTE PLAATS
DE-BRINGEN SIE DEN POLYURETHAN-/MS-POLYMERE-KLEBER AUF

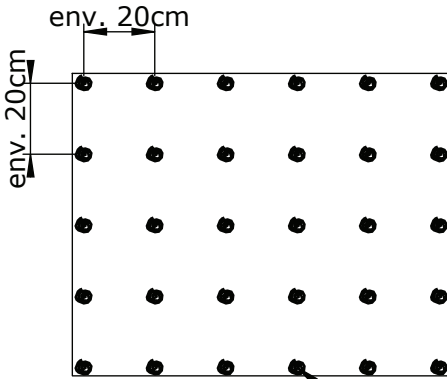

FR-Exemple receveur **100x80**

GB-Example of a **100 x 80** shower tray

ES-Ejemplo de plato de ducha **100 x 80**

PT-Exemplo de base de duche **100 x 80**

IT-Esempio di piatto doccia **100 x 80**

NL-Voorbeeld met douchebak **100 x 80**

DE-Beispiel mit Duschwanne **100 x 80**

FR-Colle Polyuréthane ou MS Polymère

GB-Polyurethane adhesive or MS polymer

ES-Pegamento poliuretano o polimero

PT-Cola de poliuretano ou polímero MS

IT-Colla poliuretanic o MS polimero

NL-Polyurethaan of MS-polymeer lijm

DE-Polyurethan-kmebstoff oder MS-polymere

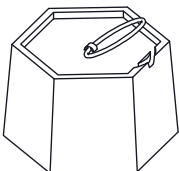
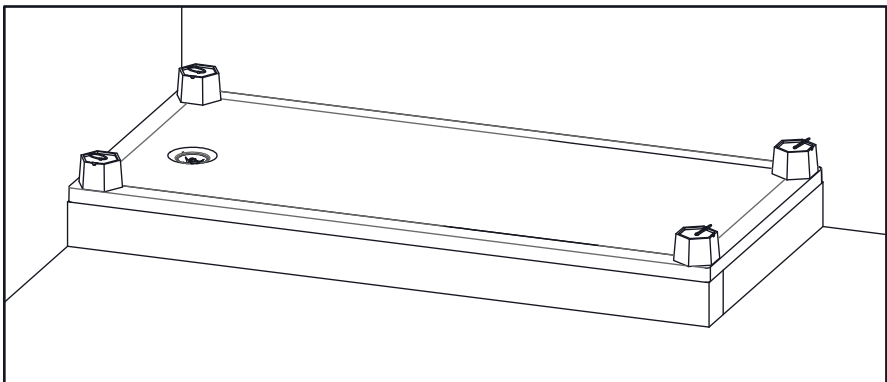

= 15Kg



24H

ES

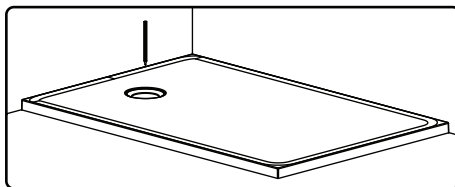

Marcar la ubicación del desagüe y presentar el plato para verificar que esté todo correcto.

- ① - silicona de acabado, antifúngica, 5 mm de anchura mínimo
- ② - silicona de estanqueidad blanda antifúngica
- ③ - elemento de soporte de la junta de silicona
- ④ - silicona de apoyo

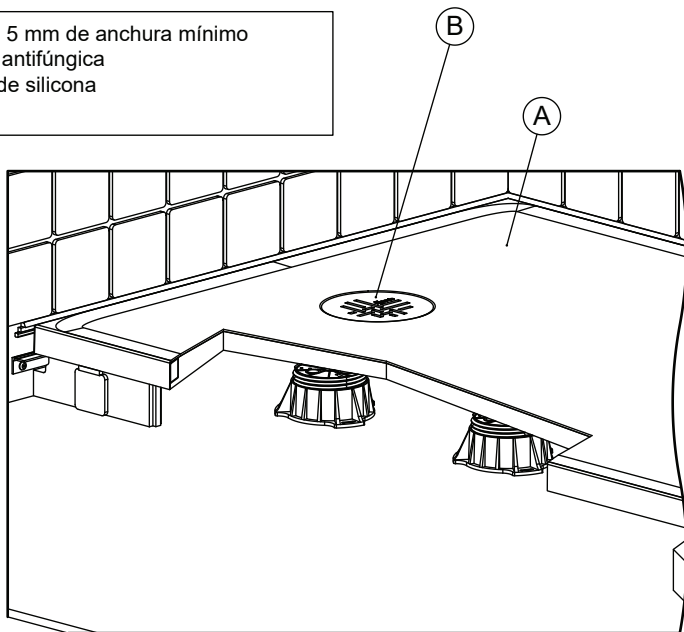
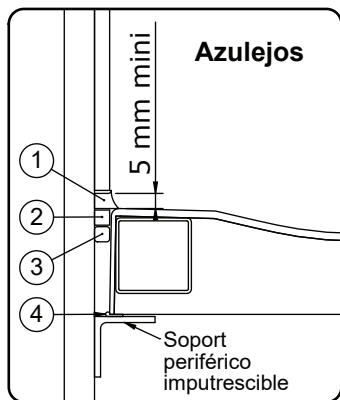

Es imprescindible instalar un soporte imputrescible en todos los lados del plato.

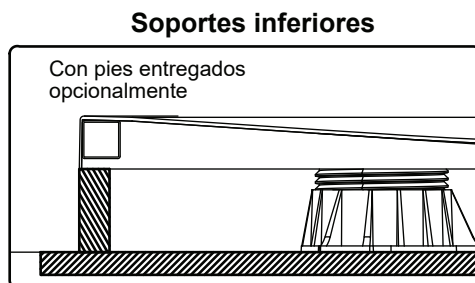
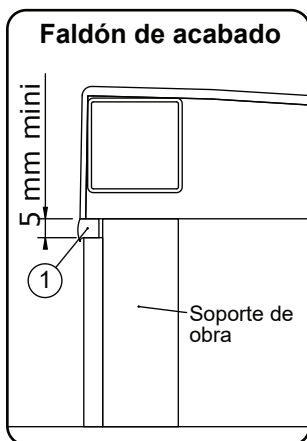
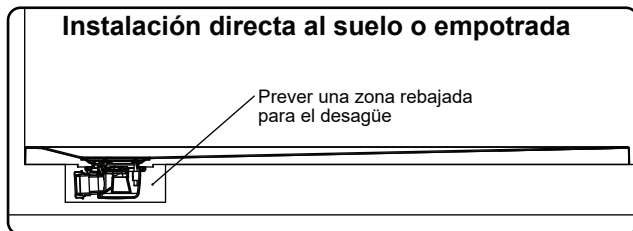



Durante las obras, proteger el plato de ducha de posibles daños como quemaduras, choques, arañazos...



La instalación de una válvula de compensación es necesaria para un uso óptimo, en caso de conectar otro aparato al desagüe del plato.

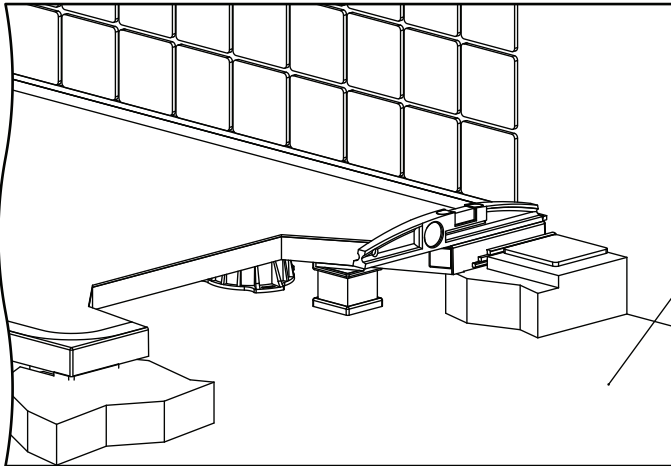

Imprescindible: suelo rígido y sin humedades

No coloque en calefacción por suelo radiante.

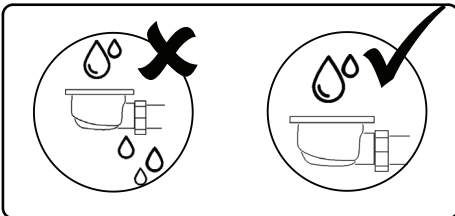

Instalación directa al suelo

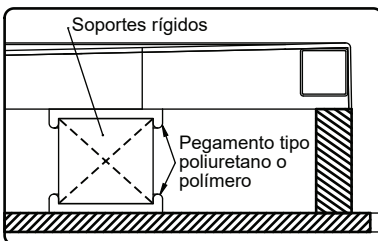
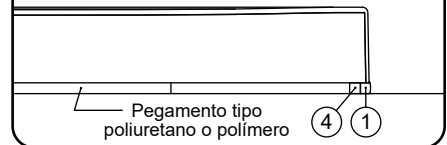

Instalación empotrado en el suelo

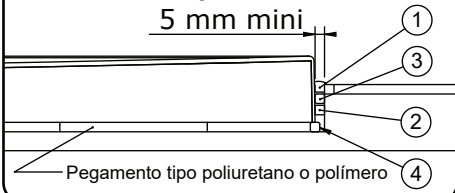

TIPOS DE INSTALACIÓN

1. Instalación sobre pies regulables con revestimiento de baldosas



Instalación de un soporte periférico indispensable

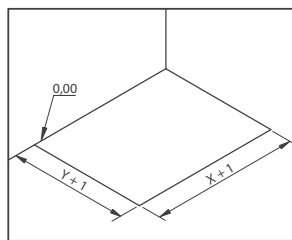
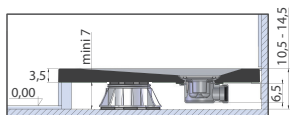

Preparación para la implantación

2. Instalación directa al suelo

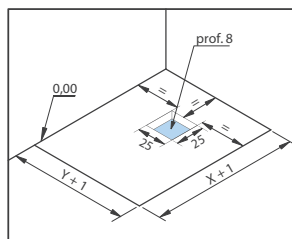
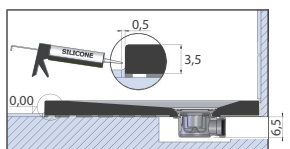
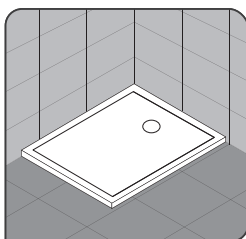

Preparación para la implantación

3. Empotrado e instalado sobre pies regulables



Instalación de un soporte periférico indispensable

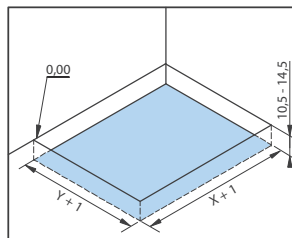
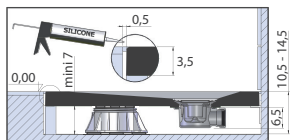

Preparación para la implantación

4. Empotrado e instalado sin pies regulables

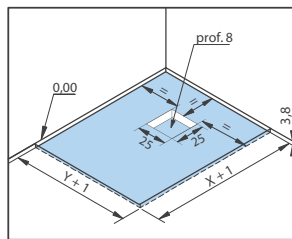
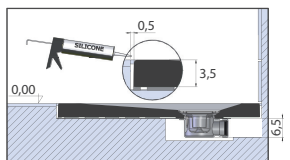
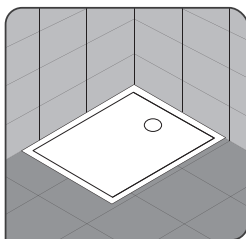

Preparación para la implantación

X	Y
80	80
90	90
100	100
100	70
100	80
100	90
120	70
120	80
120	90
120	100
140	70
140	80
140	90
140	100
160	70
160	80
160	90
160	100
170	70
170	80
170	90
180	70
180	80
180	90
180	100

- FR**-MISE EN PLACE DES PLOTS DE COLLE POLYURETHANE OU MS POLYMERE
GB-PLACEMENT OF POLYURETHANE OR MS POLYMER GLUE PLUGS
ES-COLOCACIÓN DE PLACAS DE PEGAMENTO DE POLIURETANO O MS POLYMER
PT-POSICÃO DOS PONTOS DE COLA DE POLIURETANO OU POLÍMERO MS
IT-POSIZIONAMENTO PIASTRE DI COLLA POLIURETANO O MS POLIMERO
NL-BRENG DE POLYURETAAN LIJM OF MS POLYMEERAAN OP DE JUISTE PLAATS
DE-BRINGEN SIE DEN POLYURETHAN-/MS-POLYMERE-KLEBER AUF

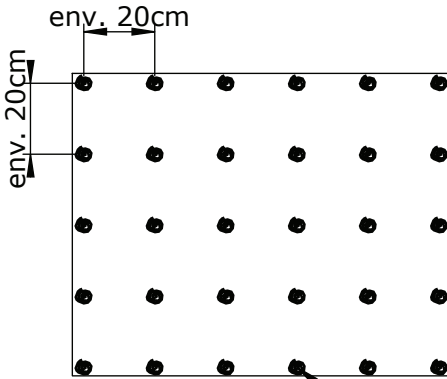

FR-Exemple receveur **100x80**

GB-Example of a **100 x 80** shower tray

ES-Ejemplo de plato de ducha **100 x 80**

PT-Exemplo de base de duche **100 x 80**

IT-Esempio di piatto doccia **100 x 80**

NL-Voorbeeld met douchebak **100 x 80**

DE-Beispiel mit Duschwanne **100 x 80**

FR-Colle Polyuréthane ou MS Polymère

GB-Polyurethane adhesive or MS polymer

ES-Pegamento poliuretano o polimero

PT-Cola de poliuretano ou polímero MS

IT-Colla poliuretanic o MS polimero

NL-Polyurethaan of MS-polymeer lijm

DE-Polyurethan-kmebstoff oder MS-polymere

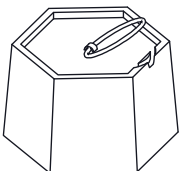
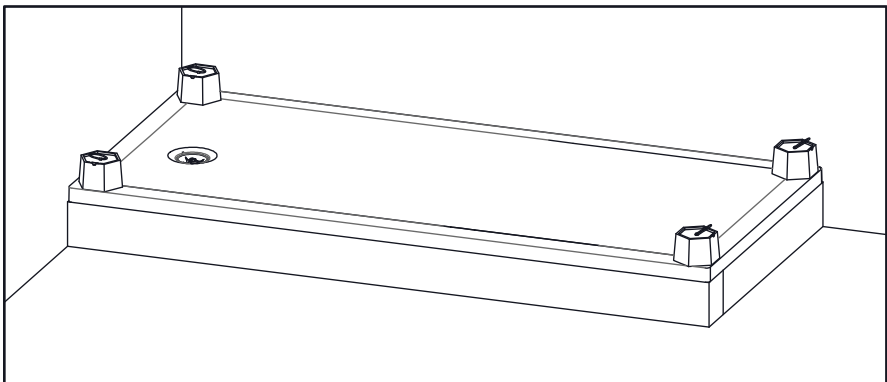

= 15Kg



24H

PT

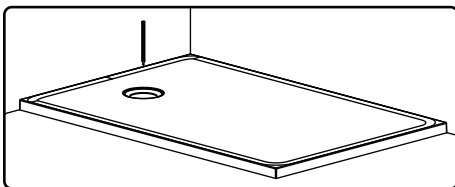

Marcar a localização da válvula e colocar a válvula na base para verificar se a localização é a correta.

- ① - silicone de acabamento, antifúngico com largura mínima de 5 mm
- ② - selante silicone macio com tratamento antifúngico
- ③ - elemento de suporte da junta de silicone
- ④ - suporte de silicone

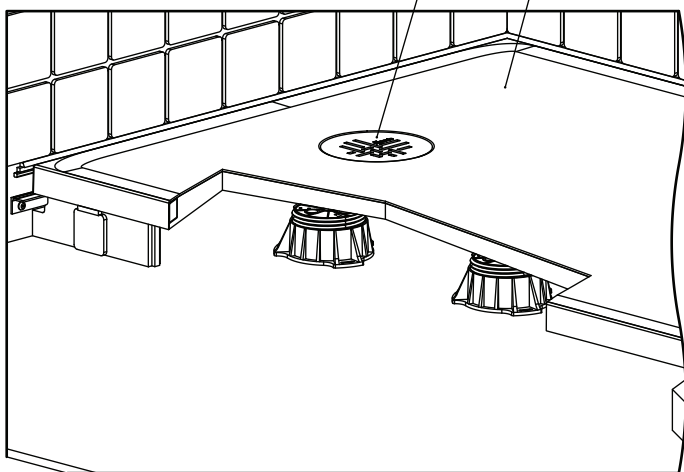
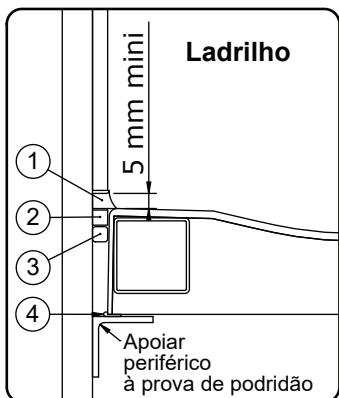

É fundamental instalar um suporte à prova de podridão em todos os lados da placa.

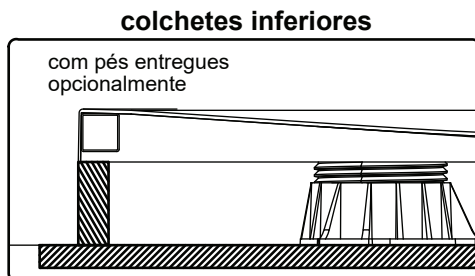
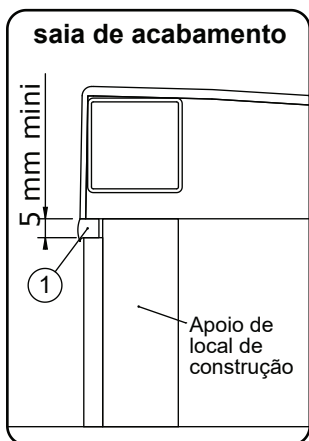
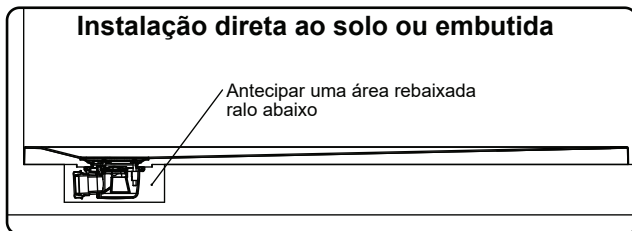



Durante toda a duração da obra, proteger a base de qualquer dano: queimadura, impacto, risco...



Instalar uma válvula anti-vácuo para um bom funcionamento, caso outro elemento sanitário esteja ligado à mesma evacuação.

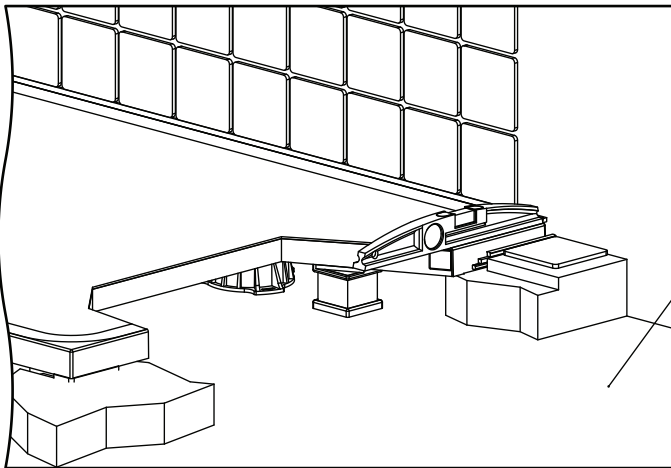

essencial: solo rígido e livre de umidade

não coloque em aquecimento de piso radiante.

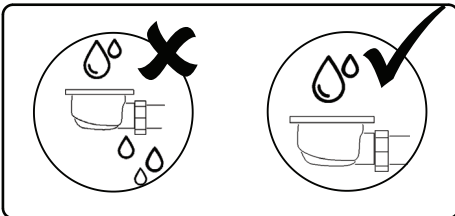

Instalação direta no solo

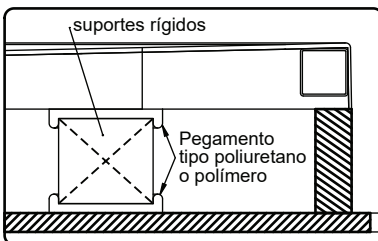
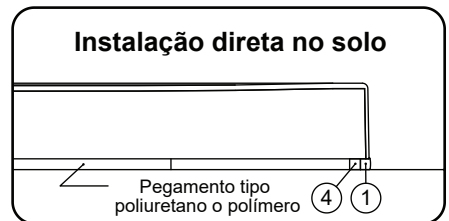

Instalação embutida no solo

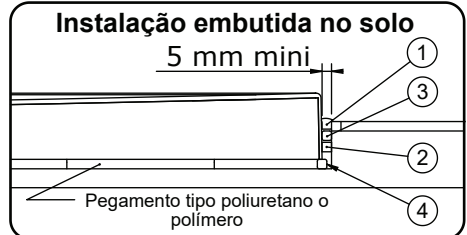

TIPOS DE INSTALAÇÕES POSSÍVEIS

1. Instalação em pés ajustáveis com cobertura de azulejo



Instalação de um suporte periférico essencial

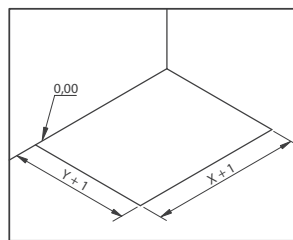
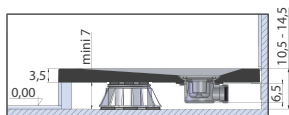

Preparação da execução

2. Deitado em azulejos

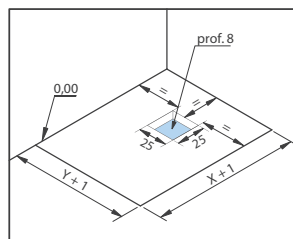
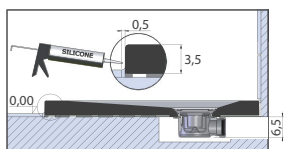
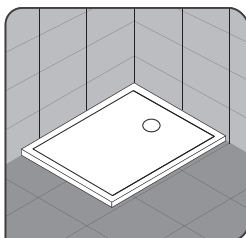

Preparação da execução

3. Recesso e instalação com pés ajustáveis



Instalação de um suporte periférico essencial

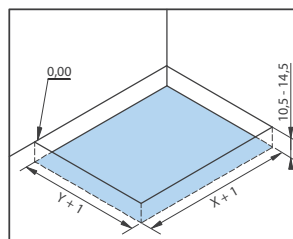
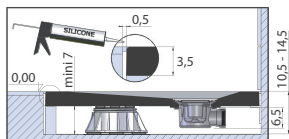

Preparação da execução

4. Recesso e instalação sem pés reguláveis

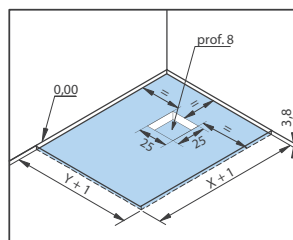
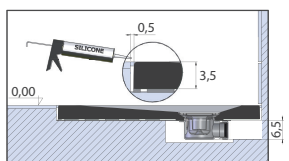
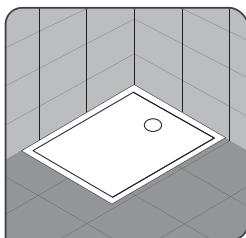

Preparação da execução

X	Y
80	80
90	90
100	100
100	70
100	80
100	90
120	70
120	80
120	90
120	100
140	70
140	80
140	90
140	100
160	70
160	80
160	90
160	100
170	70
170	80
170	90
180	70
180	80
180	90
180	100

- FR**-MISE EN PLACE DES PLOTS DE COLLE POLYURETHANE OU MS POLYMERE
GB-PLACEMENT OF POLYURETHANE OR MS POLYMER GLUE PLUGS
ES-COLOCACIÓN DE PLACAS DE PEGAMENTO DE POLIURETANO O MS POLYMER
PT-POSICÃO DOS PONTOS DE COLA DE POLIURETANO OU POLÍMERO MS
IT-POSIZIONAMENTO PIASTRE DI COLLA POLIURETANO O MS POLIMERO
NL-BRENG DE POLYURETAAN LIJM OF MS POLYMEERAAN OP DE JUISTE PLAATS
DE-BRINGEN SIE DEN POLYURETHAN-/MS-POLYMERE-KLEBER AUF

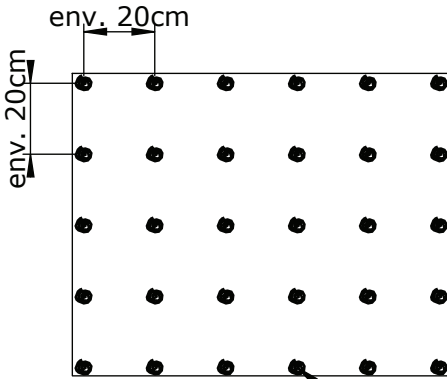

FR-Exemple receveur **100x80**

GB-Example of a **100 x 80** shower tray

ES-Ejemplo de plato de ducha **100 x 80**

PT-Exemplo de base de duche **100 x 80**

IT-Esempio di piatto doccia **100 x 80**

NL-Voorbeeld met douchebak **100 x 80**

DE-Beispiel mit Duschwanne **100 x 80**

FR-Colle Polyuréthane ou MS Polymère

GB-Polyurethane adhesive or MS polymer

ES-Pegamento poliuretano o polimero

PT-Cola de poliuretano ou polímero MS

IT-Colla poliuretanic o MS polimero

NL-Polyurethaan of MS-polymeer lijm

DE-Polyurethan-kmebstoff oder MS-polymere

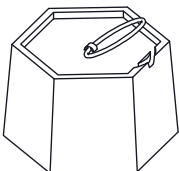
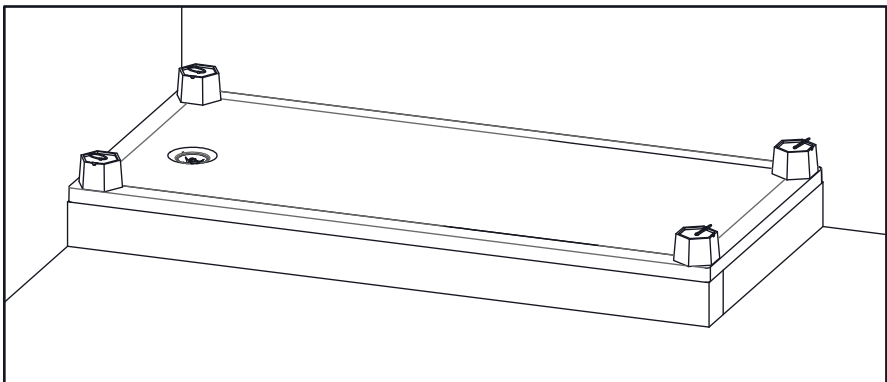

= 15Kg



24H

IT

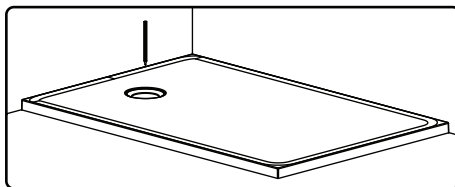

Tracciare la posizione dello scarico e fare un Montaggio cieco dello scarico e della vaschetta.

- ① - silicone di finitura antimuffa di larghezza minima di 5mm
- ② - Silicone morbido sigillante antimuffa
- ③ - elemento di supporto silicone
- ④ - supporto di silicone

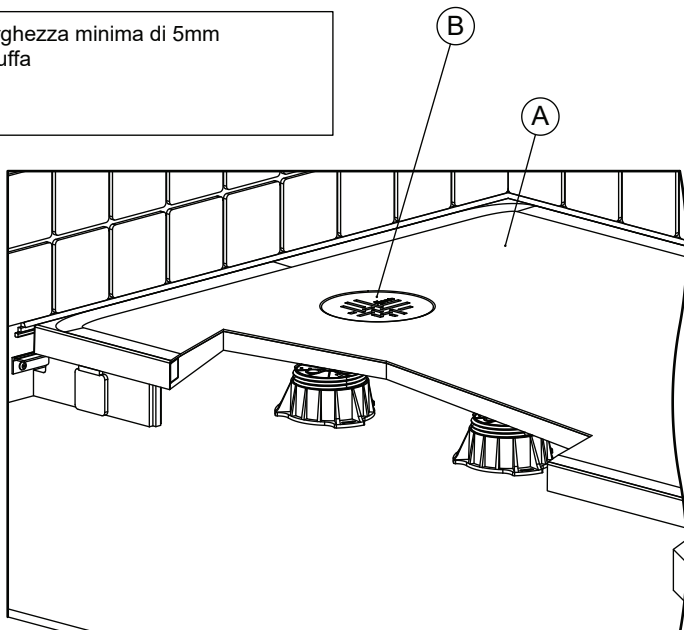
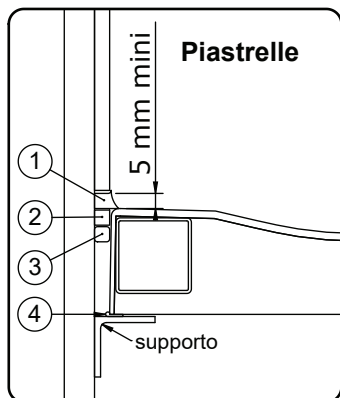

è indispensabile avere un supporto antimuffa su tutti i lati del piatto

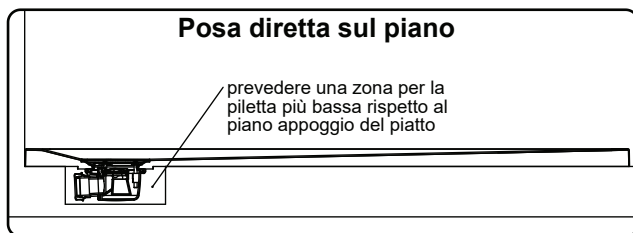

Pannello rivestimento

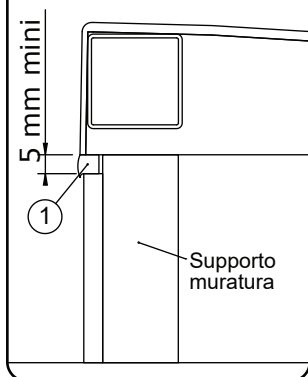

supporto di fondo

con piedi forniti in opzione

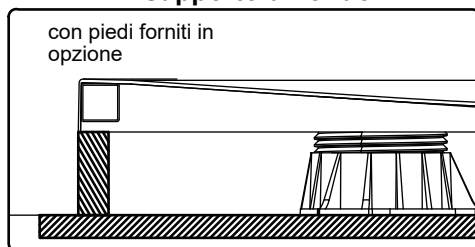



Durante tutta la durata dei lavori proteggere il piatto da eventuali abrasioni, colpi o rottura



Installazione di una valvola antivoto è necessario per l'uso ottimale se un altro apparecchio sanitario è collegato allo stesso scarico

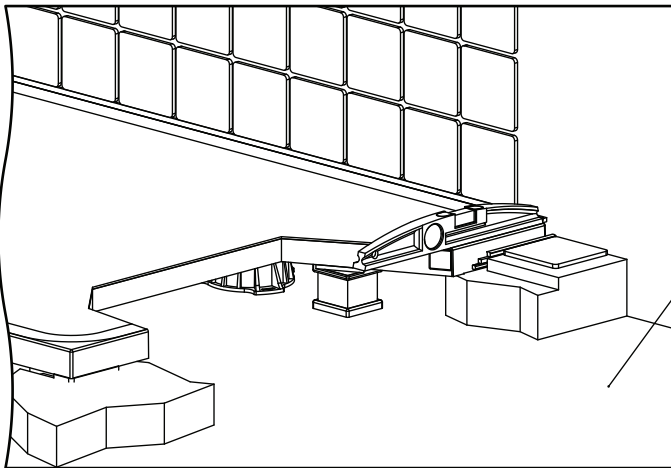

il suolo deve esser rigido e non umido

Non sdraiarti riscaldamento a pavimento.

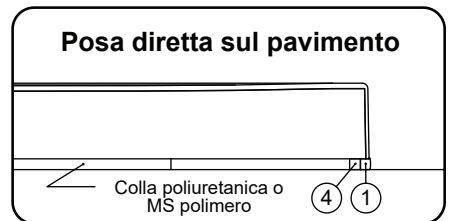
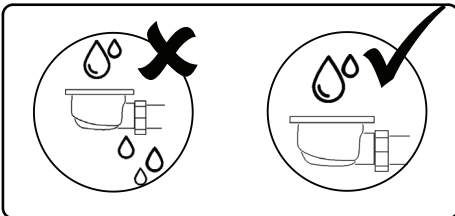

Posa diretta sul pavimento

Colla poliuretantica o MS polimero

4 1

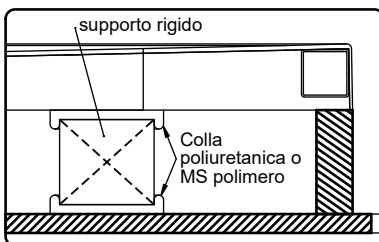

supporto rigido

Colla poliuretantica o MS polimero

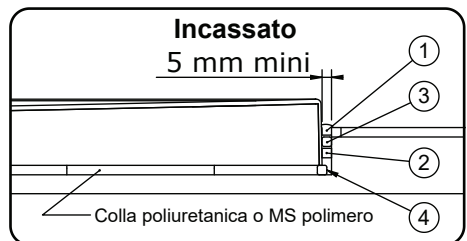

Incassato
5 mm mini

Colla poliuretantica o MS polimero

1
3
2
4

TIPI DI INSTALLAZIONE POSSIBILE

1. Posa su piedi regolabili con rivestimento piastrellato



Installazione di un supporto periferico essenziale

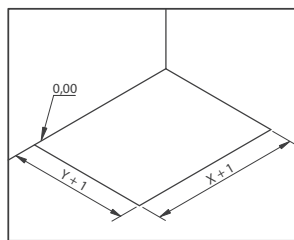
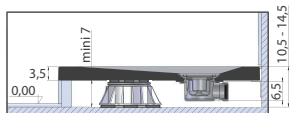

Preparazione per l'impianto

2. Posa su piastrelle

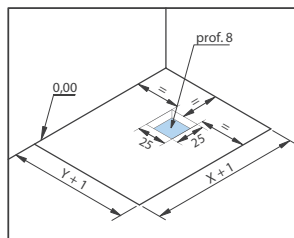
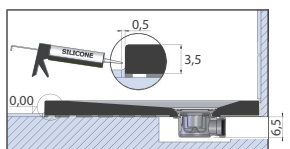
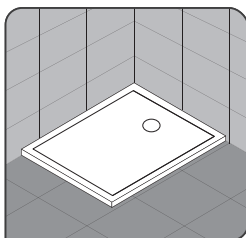

Preparazione per l'impianto

3. Incasso e posa con piedi regolabili



Installazione di un supporto periferico essenziale

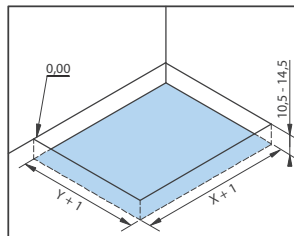
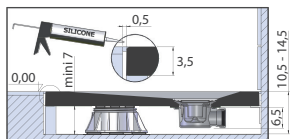

Preparazione per l'impianto

4. Incasso e posa senza piedi regolabili

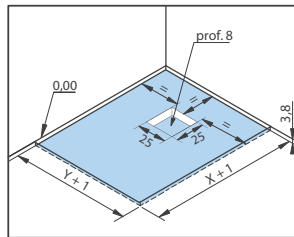
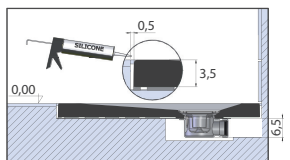
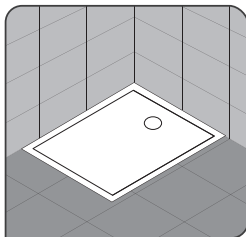

Preparazione per l'impianto

X	Y
80	80
90	90
100	100
100	70
100	80
100	90
120	70
120	80
120	90
120	100
140	70
140	80
140	90
140	100
160	70
160	80
160	90
160	100
170	70
170	80
170	90
180	70
180	80
180	90
180	100

FR-MISE EN PLACE DES PLOTS DE COLLE POLYURETHANE OU MS POLYMERE
GB-PLACEMENT OF POLYURETHANE OR MS POLYMER GLUE PLUGS
ES-COLOCACIÓN DE PLACAS DE PEGAMENTO DE POLIURETANO O MS POLYMER
PT-POSICÃO DOS PONTOS DE COLA DE POLIURETANO OU POLÍMERO MS
IT-POSIZIONAMENTO PIASTRE DI COLLA POLIURETANO O MS POLIMERO
NL-BRENG DE POLYURETAAN LIJM OF MS POLYMEERAAN OP DE JUISTE PLAATS
DE-BRINGEN SIE DEN POLYURETHAN-/MS-POLYMERE-KLEBER AUF

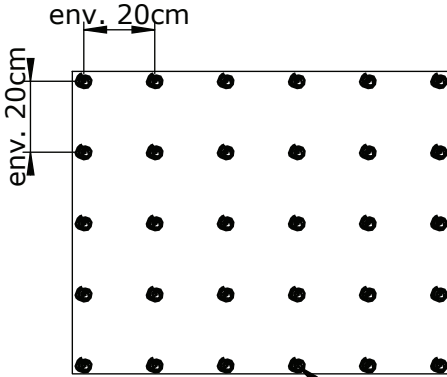

FR-Exemple receveur **100x80**

GB-Example of a **100 x 80** shower tray

ES-Ejemplo de plato de ducha **100 x 80**

PT-Exemplo de base de duche **100 x 80**

IT-Esempio di piatto doccia **100 x 80**

NL-Voorbeeld met douchebak **100 x 80**

DE-Beispiel mit Duschwanne **100 x 80**

FR-Colle Polyuréthane ou MS Polymère

GB-Polyurethane adhesive or MS polymer

ES-Pegamento poliuretano o polimero

PT-Cola de poliuretano ou polímero MS

IT-Colla poliuretanic o MS polimero

NL-Polyurethaan of MS-polymeer lijm

DE-Polyurethan-kmebstoff oder MS-polymere

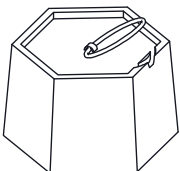
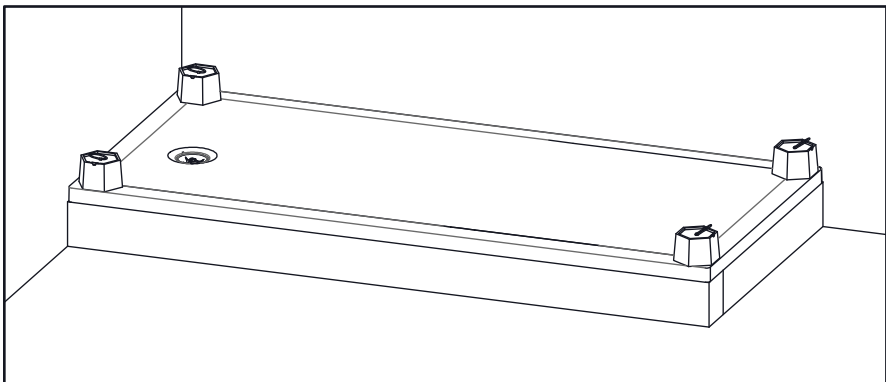

= 15Kg



24H

NL

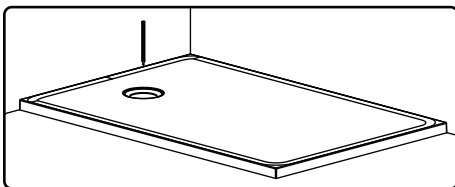

Markeer de positie van de afvoer en bepaal de plaats van de afvoer en de douchebak

- ① - Schimmelwerende siliconenkit met een lengte van minimaal 5mm
- ② - Siliconenkit voor een waterdichte afwerking, met schimmelwerende werking
- ③ - Steunelement van silicone pakking
- ④ - Siliconen ondersteuning

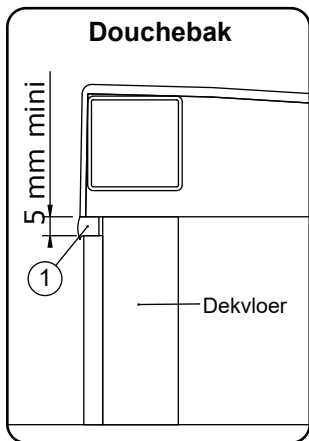
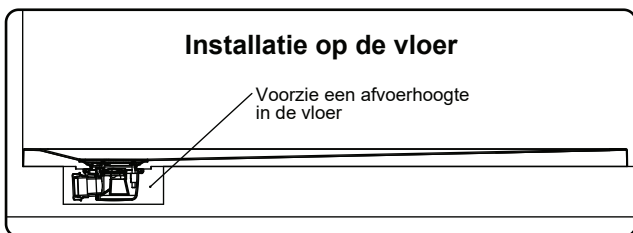
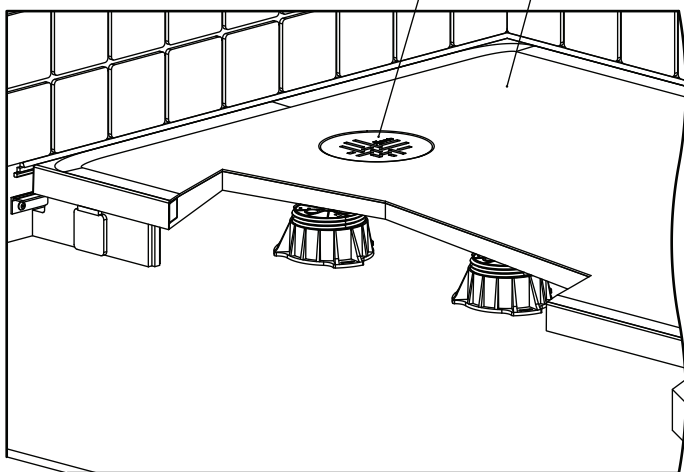
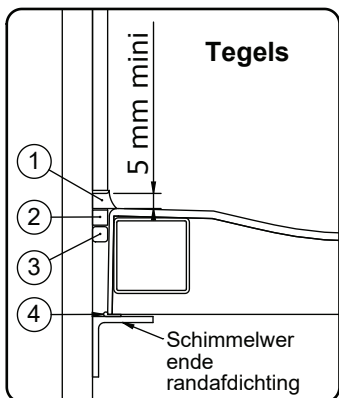

Versteving van de ondergrond

Optioneel geleverd inclusief stelpoten

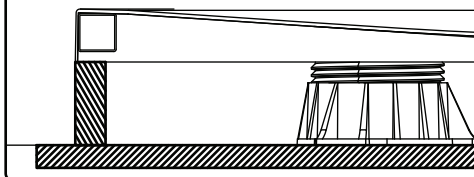



Bescherm de douchebak tijdens de werkzaamheden tegen brand, schokken, krassen etc.



Voor een optimaal gebruik is de montage van een terugslagklep noodzakelijk indien een ander sanitair toestel wordt aangesloten op dezelfde afvoer.

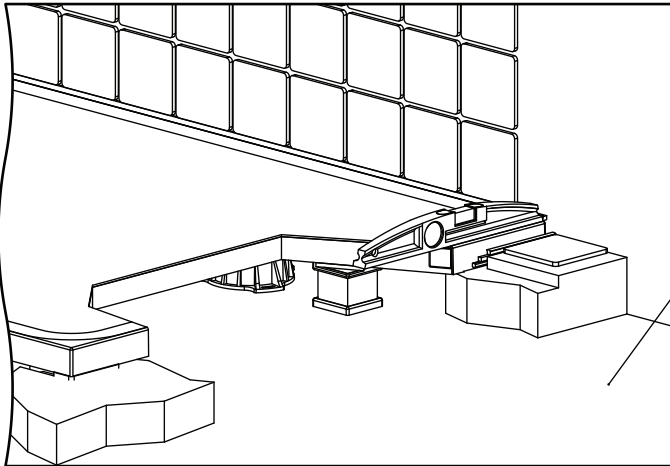

De ondergrond moet volkomen vlak en droog zijn

Niet op vloerverwarming plaatsen.

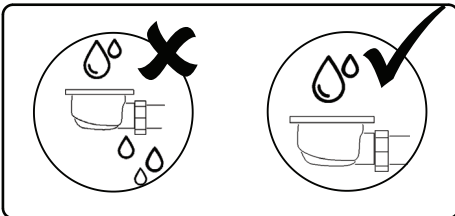

Direct op de grond

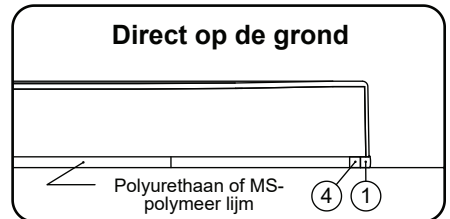

Installatie op de vloer

5 mm mini

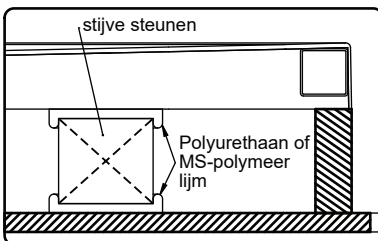
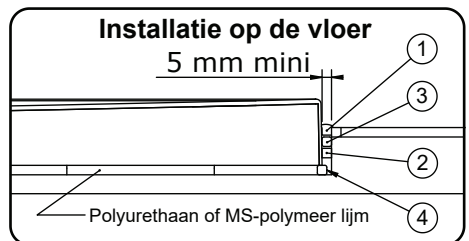

F

MOGELIJKE INSTALLATIES VOOR DOUCHEBAKKEN

1. Geplaatst op stelpoten en afgewerkt met betegeling



Aanbrengen van randversteving is noodzakelijk

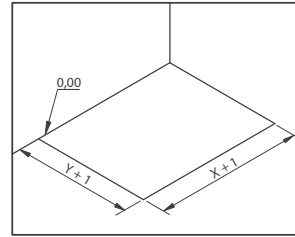
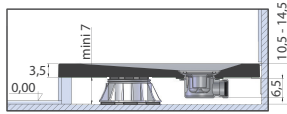

Vorbereiding montage

2. Geplaatst op tegelvloer

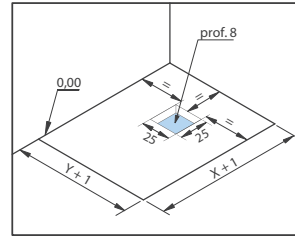
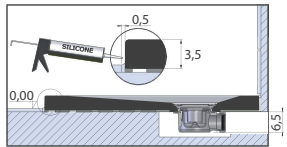
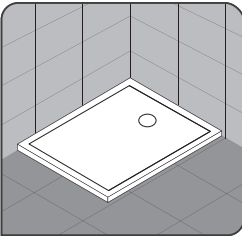

Vorbereiding montage

3. Ingebouwd en geplaatst op stelpoten



Aanbrengen van randversteving is noodzakelijk

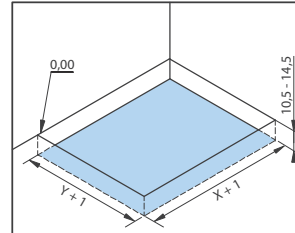
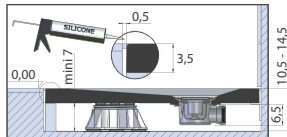

Vorbereiding montage

4. Ingebouwd en geplaatst zonder stelpoten

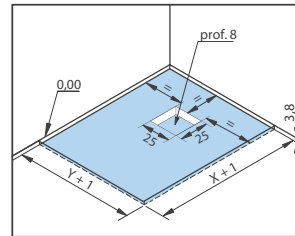
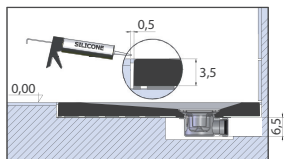
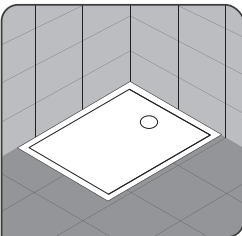

Vorbereiding montage

X	Y
80	80
90	90
100	100
100	70
100	80
100	90
120	70
120	80
120	90
120	100
140	70
140	80
140	90
140	100
160	70
160	80
160	90
160	100
170	70
170	80
170	90
180	70
180	80
180	90
180	100

- FR**-MISE EN PLACE DES PLOTS DE COLLE POLYURETHANE OU MS POLYMERE
GB-PLACEMENT OF POLYURETHANE OR MS POLYMER GLUE PLUGS
ES-COLOCACIÓN DE PLACAS DE PEGAMENTO DE POLIURETANO O MS POLYMER
PT-POSICÃO DOS PONTOS DE COLA DE POLIURETANO OU POLÍMERO MS
IT-POSIZIONAMENTO PIASTRE DI COLLA POLIURETANO O MS POLIMERO
NL-BRENG DE POLYURETAAN LIJM OF MS POLYMEERAAN OP DE JUISTE PLAATS
DE-BRINGEN SIE DEN POLYURETHAN-/MS-POLYMERE-KLEBER AUF

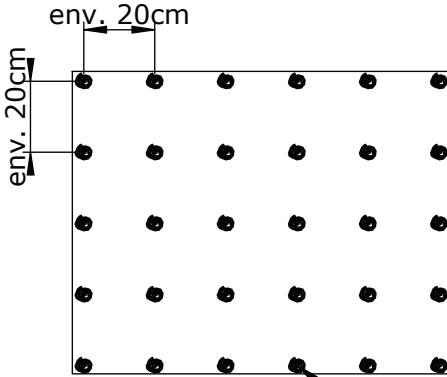

FR-Exemple receveur **100x80**

GB-Example of a **100 x 80** shower tray

ES-Ejemplo de plato de ducha **100 x 80**

PT-Exemplo de base de duche **100 x 80**

IT-Esempio di piatto doccia **100 x 80**

NL-Voorbeeld met douchebak **100 x 80**

DE-Beispiel mit Duschwanne **100 x 80**

FR-Colle Polyuréthane ou MS Polymère

GB-Polyurethane adhesive or MS polymer

ES-Pegamento poliuretano o polimero

PT-Cola de poliuretano ou polímero MS

IT-Colla poliuretana o MS polimero

NL-Polyurethaan of MS-polymeer lijm

DE-Polyurethan-kmebstoff oder MS-polymere

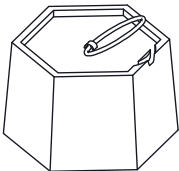
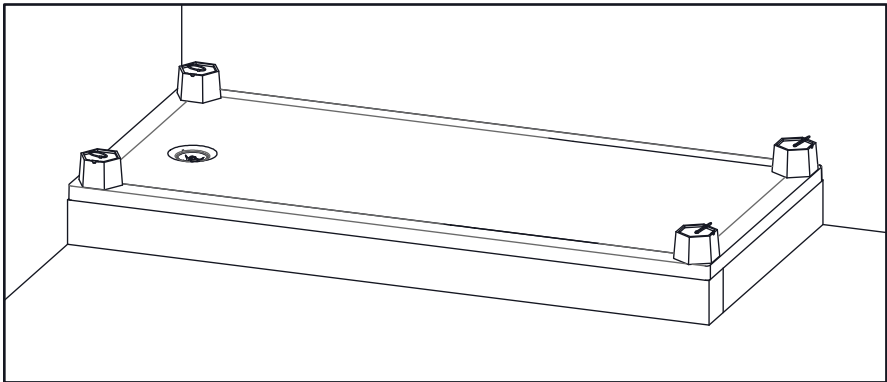

= 15Kg



24H

DE

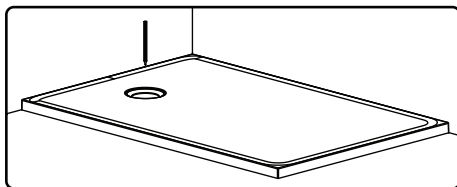

Die Position für den Ablauf anzeichnen und vormontieren

- ① - Pilzhemmendes Silikon mit einer Mindestbreite von 5mm
- ② - Weiches pilzhemmendes Dichtsilikon
- ③ - Stützelement der Silikondichtung
- ④ - Sanitärsilikon

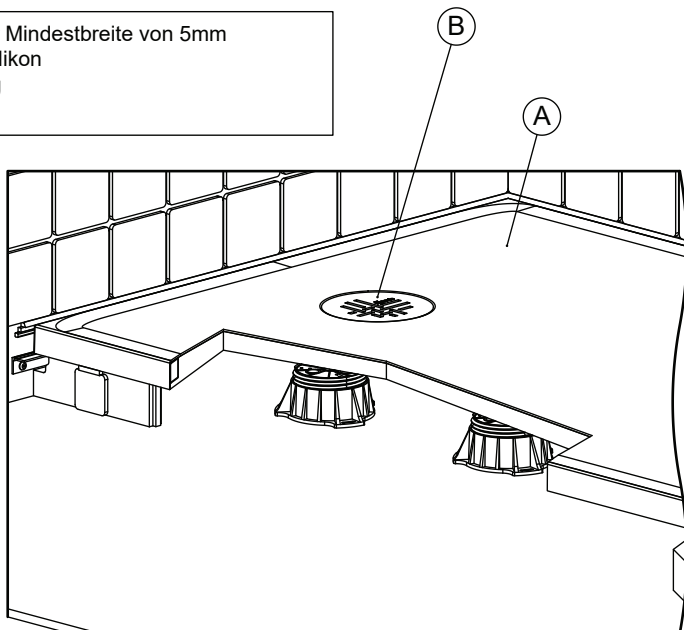
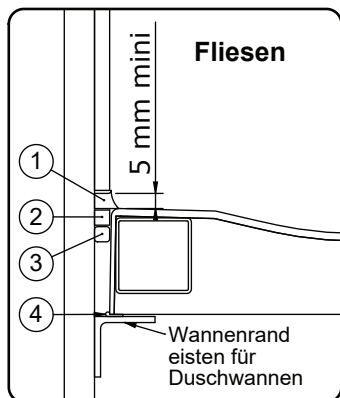

Es ist wichtig zu haben eine verrottungsfeste Unterstüztzung auf alle Seiten des Empfängers.

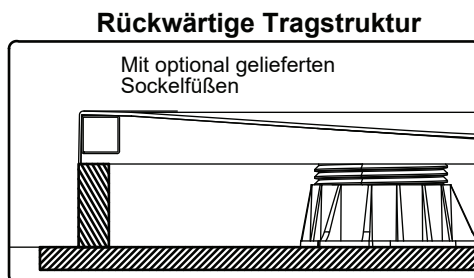
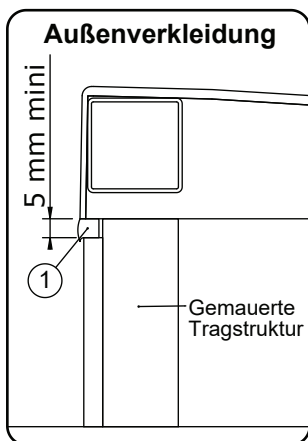
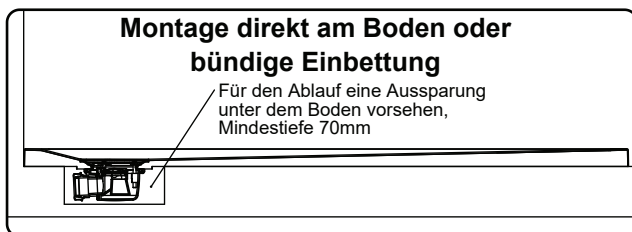

OD



Während der gesamten Dauer
der Arbeiten ist die Duschtasse
vor allen möglichen
Beschädigungen zu schützen



Montage eines Anti-Vakuum-Ventils
ist notwendig für die Verwendung
optimal, wenn ein anderes
Sanitärgerät ist mit der gleichen
Evakuierung verbunden.

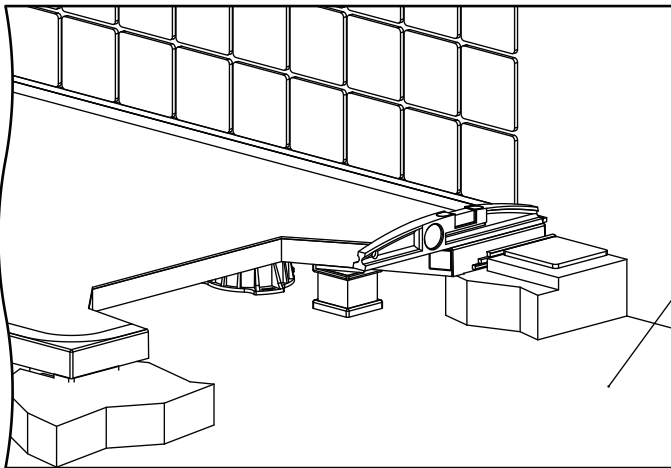

Ein fester und
trockener Untergrund
ist unabdingbar

Nicht auf
Fußbodenheizung
stellen.

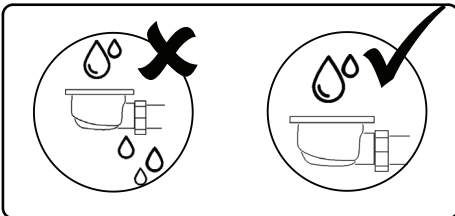

Montage direkt am Boden

Polyurethan-Klebstoff
oder MS-Polymere

4 1

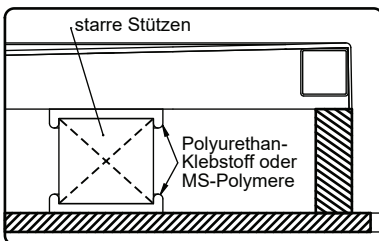

Inbouw op gelijke hoogte met de vloer

5 mm mini



ER

MONTAGEMÖGLICHKEITEN FÜR

1. Montage auf einstellbarem Fliesensockel

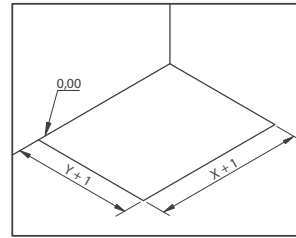
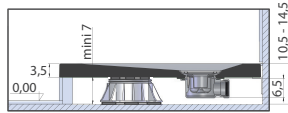
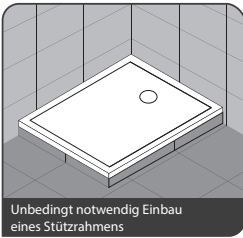

Vorbereitung der Montage

2. Auf Fliesenboden aufliegend

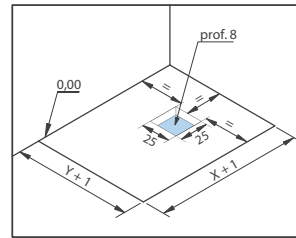
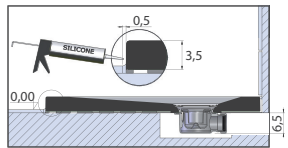
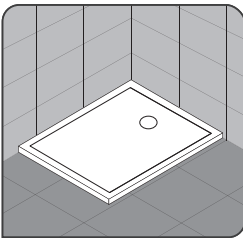

Vorbereitung der Montage

3. Eingebettet und mit einstellbarem Sockel

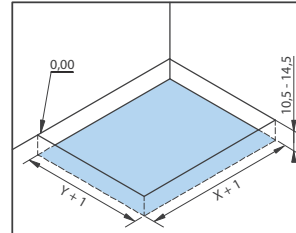
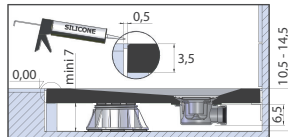
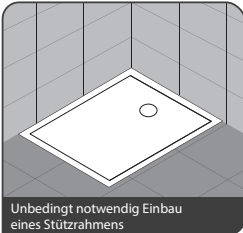

Vorbereitung der Montage

4. Eingebettet und ohne einstellbarem Sockel

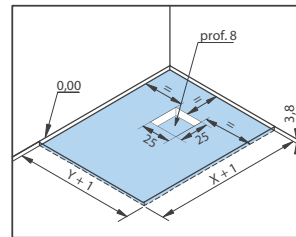
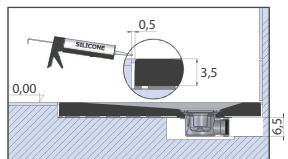
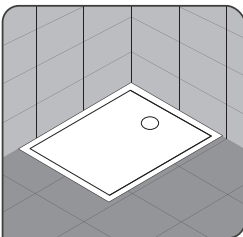

Vorbereitung der Montage

X	Y
80	80
90	90
100	100
100	70
100	80
100	90
120	70
120	80
120	90
120	100
140	70
140	80
140	90
140	100
160	70
160	80
160	90
160	100
170	70
170	80
170	90
180	70
180	80
180	90
180	100

- FR**-MISE EN PLACE DES PLOTS DE COLLE POLYURETHANE OU MS POLYMERE
GB-PLACEMENT OF POLYURETHANE OR MS POLYMER GLUE PLUGS
ES-COLOCACIÓN DE PLACAS DE PEGAMENTO DE POLIURETANO O MS POLYMER
PT-POSICÃO DOS PONTOS DE COLA DE POLIURETANO OU POLÍMERO MS
IT-POSIZIONAMENTO PIASTRE DI COLLA POLIURETANO O MS POLIMERO
NL-BRENG DE POLYURETAAN LIJM OF MS POLYMEERAAN OP DE JUISTE PLAATS
DE-BRINGEN SIE DEN POLYURETHAN-/MS-POLYMERE-KLEBER AUF

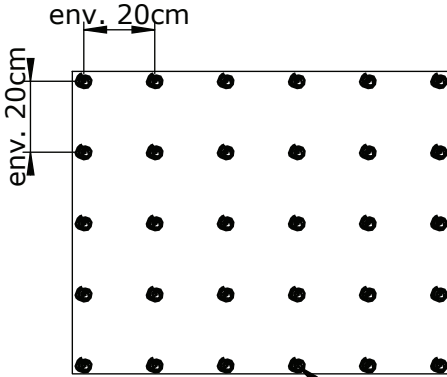

FR-Exemple receveur **100x80**

GB-Example of a **100 x 80** shower tray

ES-Ejemplo de plato de ducha **100 x 80**

PT-Exemplo de base de duche **100 x 80**

IT-Esempio di piatto doccia **100 x 80**

NL-Voorbeeld met douchebak **100 x 80**

DE-Beispiel mit Duschwanne **100 x 80**

FR-Colle Polyuréthane ou MS Polymère

GB-Polyurethane adhesive or MS polymer

ES-Pegamento poliuretano o polimero

PT-Cola de poliuretano ou polímero MS

IT-Colla poliuretanic o MS polimero

NL-Polyurethaan of MS-polymeer lijm

DE-Polyurethan-kmebstoff oder MS-polymere

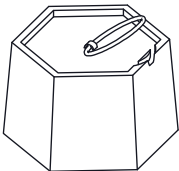
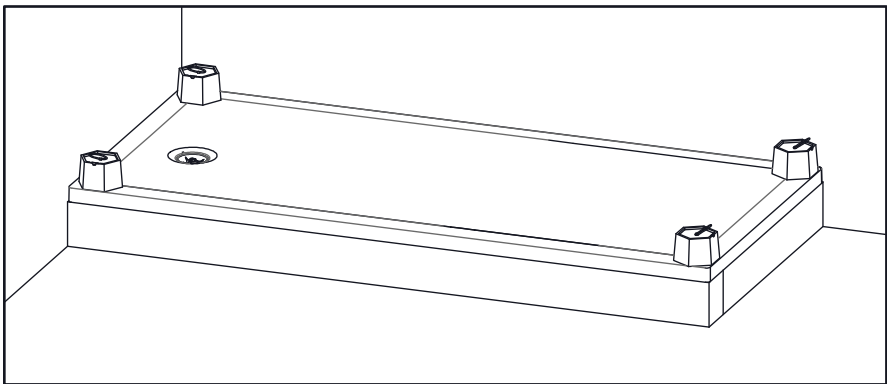

= 15Kg



24H



<p>FR</p> <p>Bon de garantie</p> <p>SCANNEZ MOI</p>  <p>http://tiny.cc/bon-de-garantie-fr</p>	<p>GB</p> <p>Guarantee</p> <p>SCAN ME</p>  <p>http://tiny.cc/bon-de-garantie-gb</p>
<p>DE</p> <p>Garantiekarte</p> <p>SCAN MICH</p>  <p>http://tiny.cc/bon-de-garantie-de</p>	<p>NL</p> <p>Garantievoorwaarden</p> <p>SCAN MIJ</p>  <p>http://tiny.cc/bon-de-garantie-nl</p>
<p>ES</p> <p>Garantía</p> <p>ESCANÉAME</p>  <p>http://tiny.cc/bon-de-garantie-es</p>	<p>IT</p> <p>Garanzia</p> <p>SCANSIONAMI</p>  <p>http://tiny.cc/bon-de-garantie-it</p>
<p>PT</p> <p>Garantia</p> <p>ESCANEEI-ME</p>  <p>http://tiny.cc/bon-de-garantie-pt</p>	<p>CH</p> <p>Garantiekarte</p> <p>SCAN MICH</p>  <p>http://tiny.cc/bon-de-garantie-ch</p>
<p>BE</p> <p>Garantievoorwaarden</p> <p>SCAN MIJ</p>  <p>http://tiny.cc/bon-de-garantie-be</p>	<p>AT</p> <p>Garantiekarte</p> <p>SCAN MICH</p>  <p>http://tiny.cc/bon-de-garantie-at</p>



Kinedo

FR

Conseils
d'entretien

SCANNEZ MOI



<http://tiny.cc/conseils-entretien-fr>

GB

Maintenance
instructions

SCAN ME



<http://tiny.cc/conseils-entretien-gb>

DE

Wartungstipps

SCAN MICH



<http://tiny.cc/conseils-entretien-de>

NL

Onderhoudstips

SCAN MIJ



<http://tiny.cc/conseils-entretien-nl>

ES

Consejos de
mantenimiento

ESCANÉAME



<http://tiny.cc/conseils-entretien-es>

IT

Consigli per la
manutenzione

SCANSIONAMI



<http://tiny.cc/conseils-entretien-it>

PT

Dicas de
manutenção

ESCANIEI-ME



<http://tiny.cc/conseils-entretien-pt>

CH

Wartungstipps

SCAN MICH



<http://tiny.cc/conseils-entretien-ch>

BE

Onderhoudstips

SCAN MIJ



<http://tiny.cc/conseils-entretien-be>

AT

Wartungstipps

SCAN MICH



<http://tiny.cc/conseils-entretien-at>



AQUAPRODUCTION, Site industriel,
F - 44680 Chaumes-en-Retz

24

EN 14527 - CL2

Aptitude au nettoyage : satisfaisant

Durabilité : satisfaisant



SERVICE APRÈS-VENTE AFTER-SALES SERVICE

FRANCE

+33 (0)2 40 21 29 45

UK

+44 (0)20 8842 0033

IRELAND

+353 04697 33102

DEUTSCHLAND

+49 (0) 6074 / 30928 0

ITALIA

+39 02 30559420

ÖSTEREICH

+43 1 710 60 70

SUISSE/SCHWEIZ

+41 (0)32 631 04 74

ESPAÑA

+34 93 544 60 76

NEDERLAND

+31 475 487 100

BELGIQUE/BELGIË

+31 475 487 100

РОССИЯ

+7 495 258-29-51

PORTUGAL

+351 219 112 785