

# Kinedo

DES1655-A

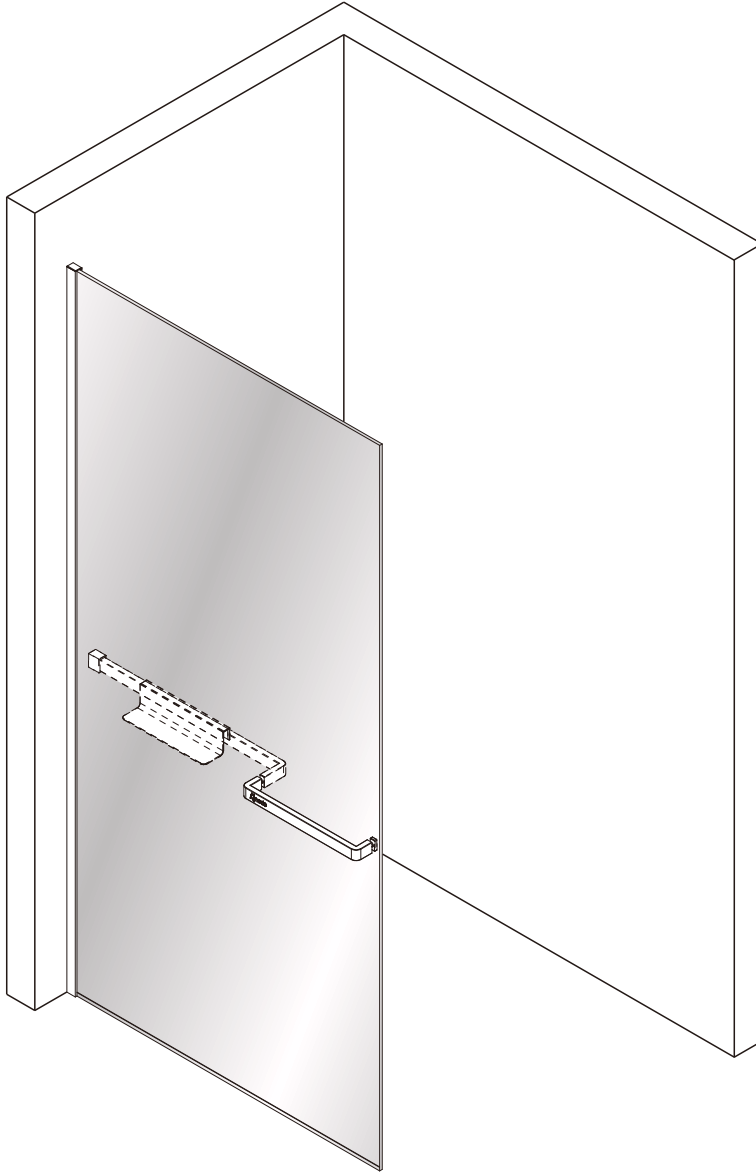

NOTICE DE MONTAGE / INSTALLATION INSTRUCTIONS / MANUAL DE INSTALACIÓN / MANUAL DE INSTALAÇÃO  
ISTRUZIONI DI MONTAGGIO / INSTALLATIE VOORSCHRIFTEN / INSTALLATIONSANLEITUNG



**RÉVERSIBILITÉ / REVERSIBILITY / REVERSIBILITAD / REVERSIBILIDADE**  
**REVERSIBILITÀ / OMKEERBAARHEID / WAHLWEISE MONTAGE**

**Montage à gauche**  
 Left hand  
**Montaje a la izquierda**  
 Montagem à esquerda  
**Montaggio a sinistra**  
 Montage links  
**Montage links**

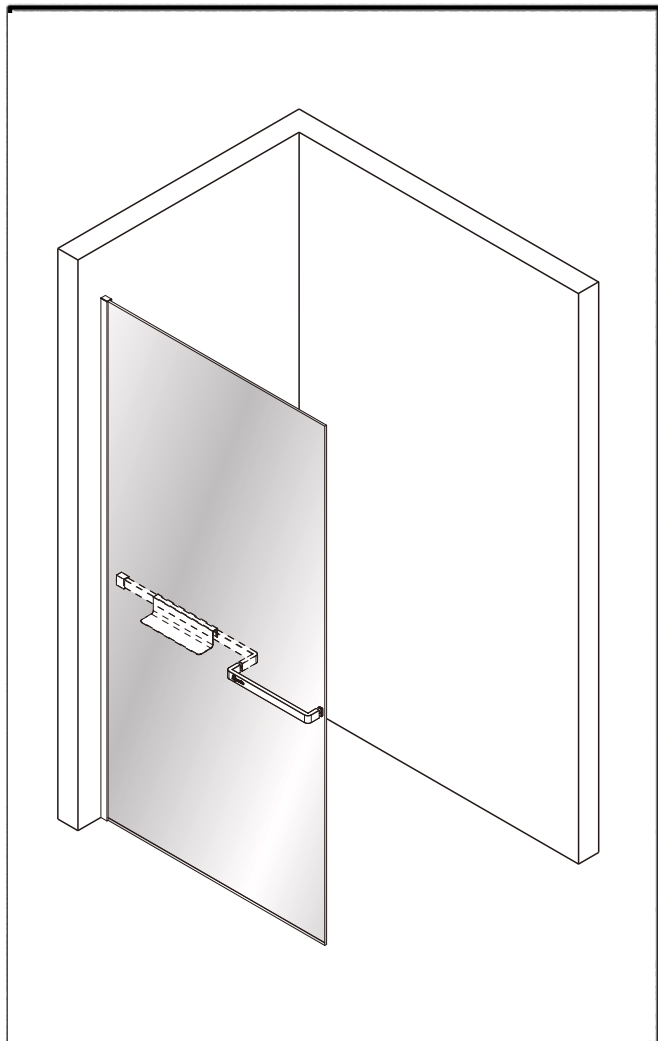

**Montage à droite**  
 Right hand  
**Montaje a la derecha**  
 Montagem à direita  
**Montaggio a destra**  
 Montage rechts  
**Montage rechts**

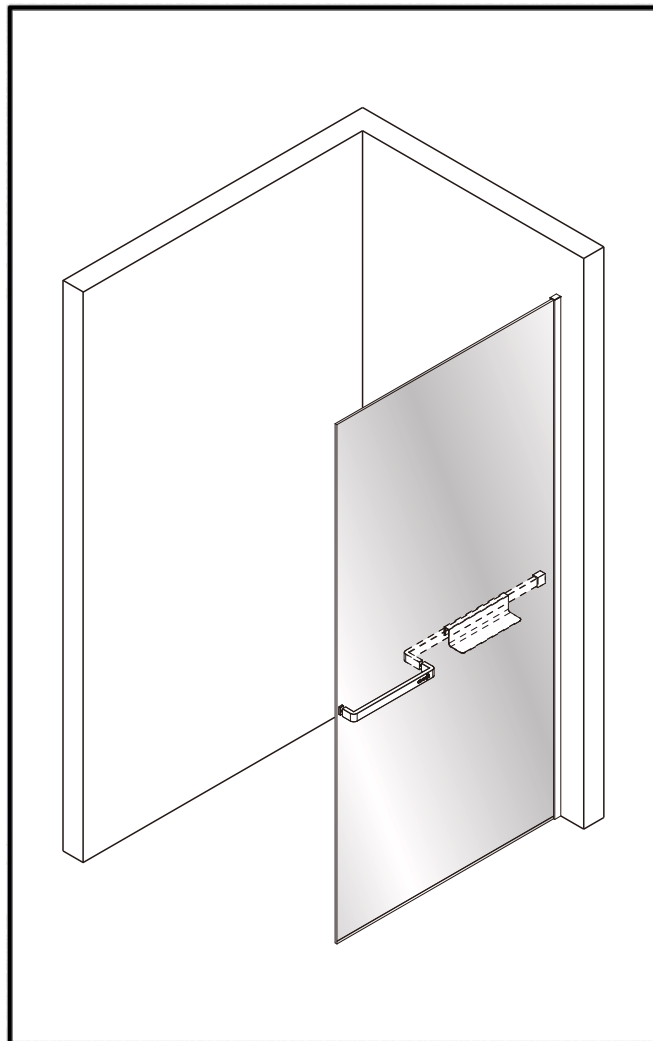

**Vous avez la possibilité de réaliser un montage à droite ou un montage à gauche. Notre notice d'installation décrit un montage à gauche. Si vous voulez réaliser un montage à droite, il vous suffit d'inverser le montage.**

This cubicle can be installed either left or right hand. These installation instructions show a left hand installation.

**Puede realizar un montaje a la derecha o un montaje a la izquierda. Nuestro folleto de instalación describe un montaje a la izquierda. Si desea montar su cabina a la derecha sólo tendrá que realizar el montaje al contrario.**

Você pode montar à direita ou montar à esquerda.

Nosso folheto de instalação descreve uma montagem à esquerda. Se quiser montar sua cabine à direita, basta montá-la à direita.







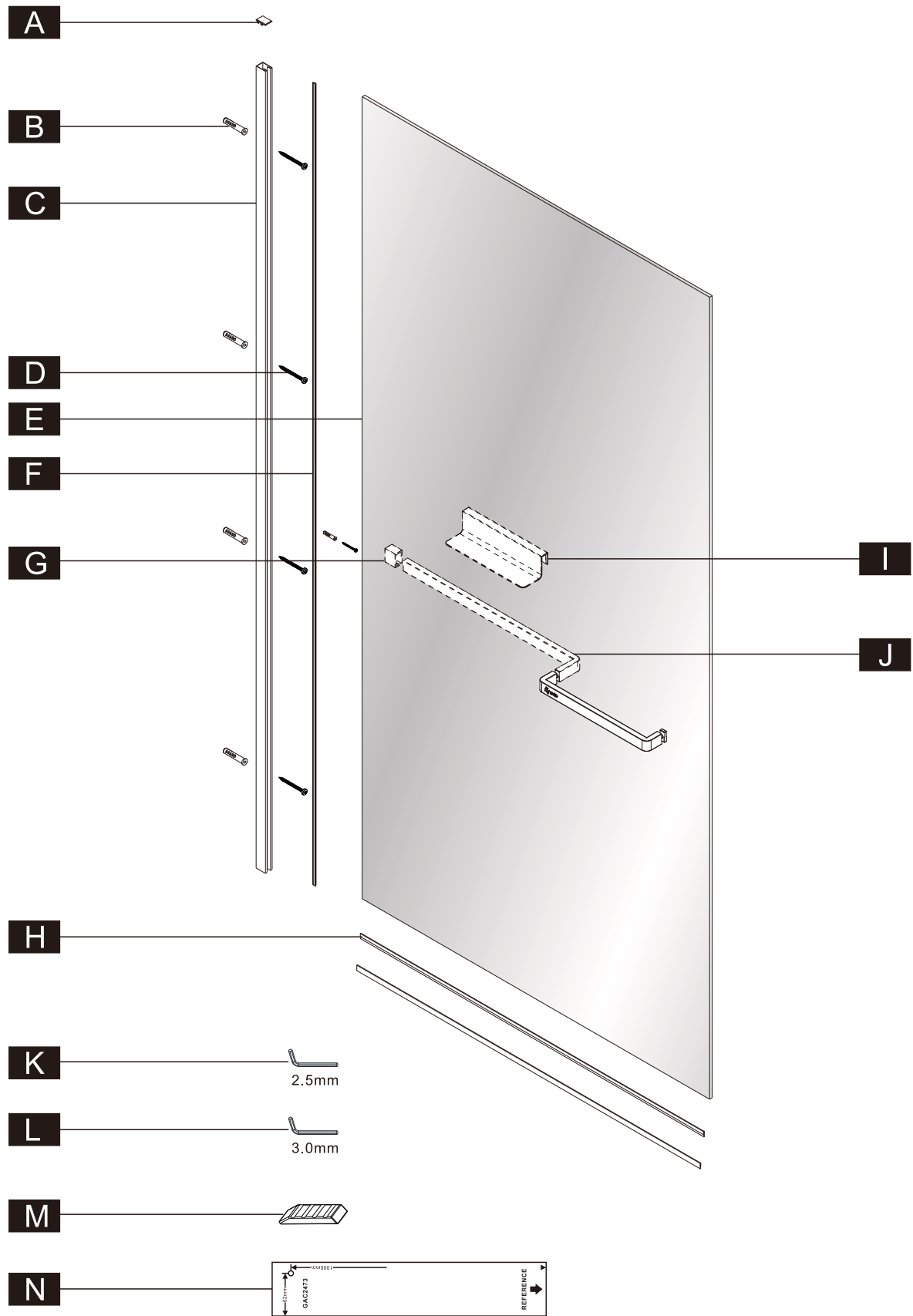

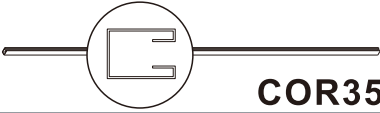

**Avete la possibilità di effettuare il montaggio a destra o a sinistra. Il nostro manuale descrive il montaggio a sinistra. Se volete realizzare il montaggio a destra è sufficiente invertire varie fasi di montaggio.**

U kunt de douchecabine rechts of links monteren. Onze handleiding beschrijft de links montage van de cabine. Keer de montage om als u de cabine rechts wilt monteren.

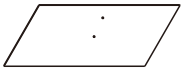
**Sie haben die Möglichkeit, eine Montage auf der linken Seite oder eine Montage auf der rechten Seite durchzuführen. Unsere Montageanleitung beschreibt eine Montage auf der linken Seite. Wenn Sie die Montage lieber auf der rechten Seite durchführen wollen, müssen Sie nur den Montageprozess umkehren.**

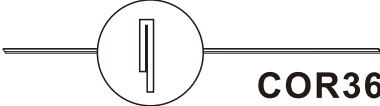
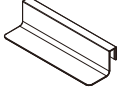
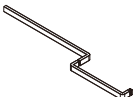
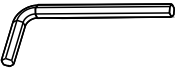

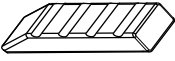
## PARTS LIST

NUMBER	IMAGE	SIZE(mm)	QUANTITY
A	 PPLA721		1
B	 CHE02	Φ6mm	5
C	 COR35	L=2000mm	1
D	 VIS231	ST4*45	5
E			1
F	 JOI385	L=2000mm	1
G	 KIT231		1
H	 COR36	800:L=772 900:L=872 1000:L=972 1200:L=1172 1400:L=1372	2
I	 KIT233	L=250mm	1
J	 KIT231	800:L=712 900:L=812 1000:L=912 1200:L=1112 1400:L=1312	1
K		2.5mm	1
L		3.0mm	1
M			1
N	 GAC2473		1

---

TOOLS NEEDED FOR THE INSTALLATION:

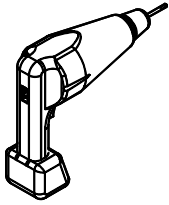

6mm

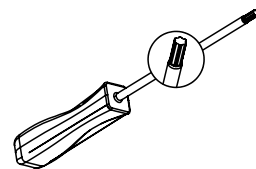
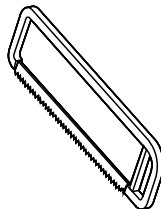
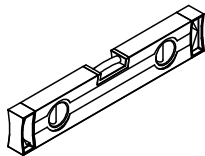
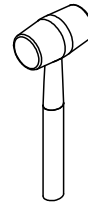
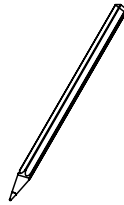
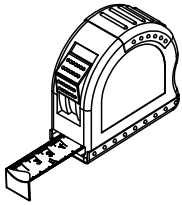
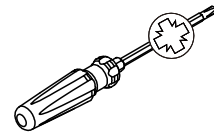

T20

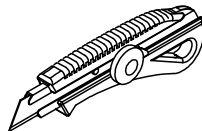

8mm

01

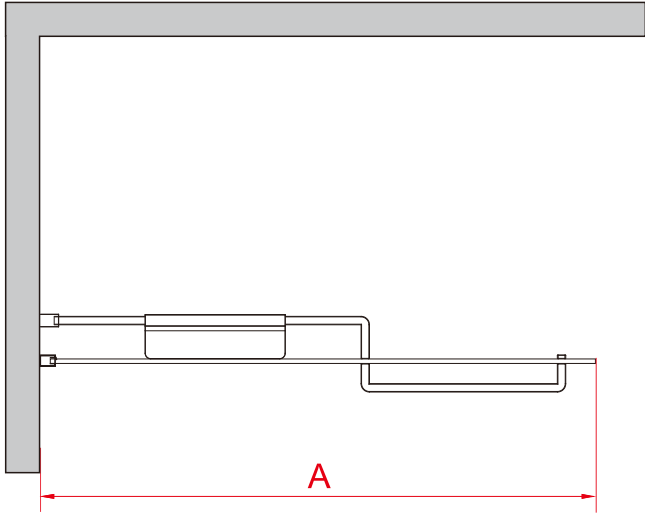

SIZE	A
800	775-790
900	875-890
1000	975-990
1200	1175-1190
1400	1375-1390

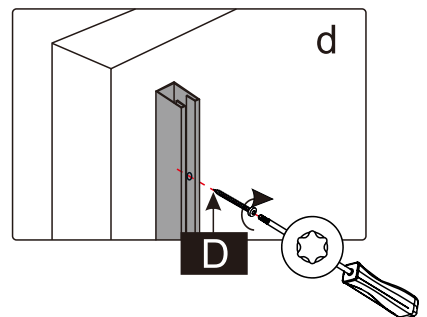
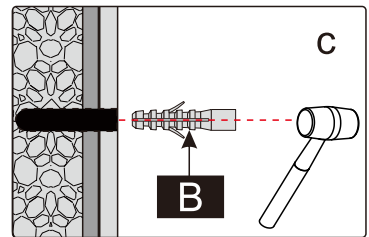
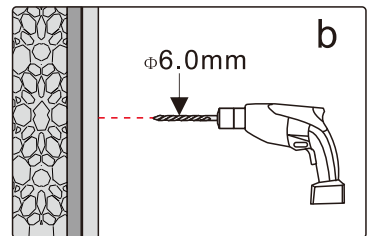
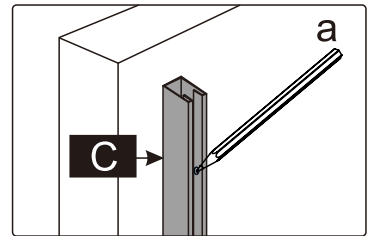
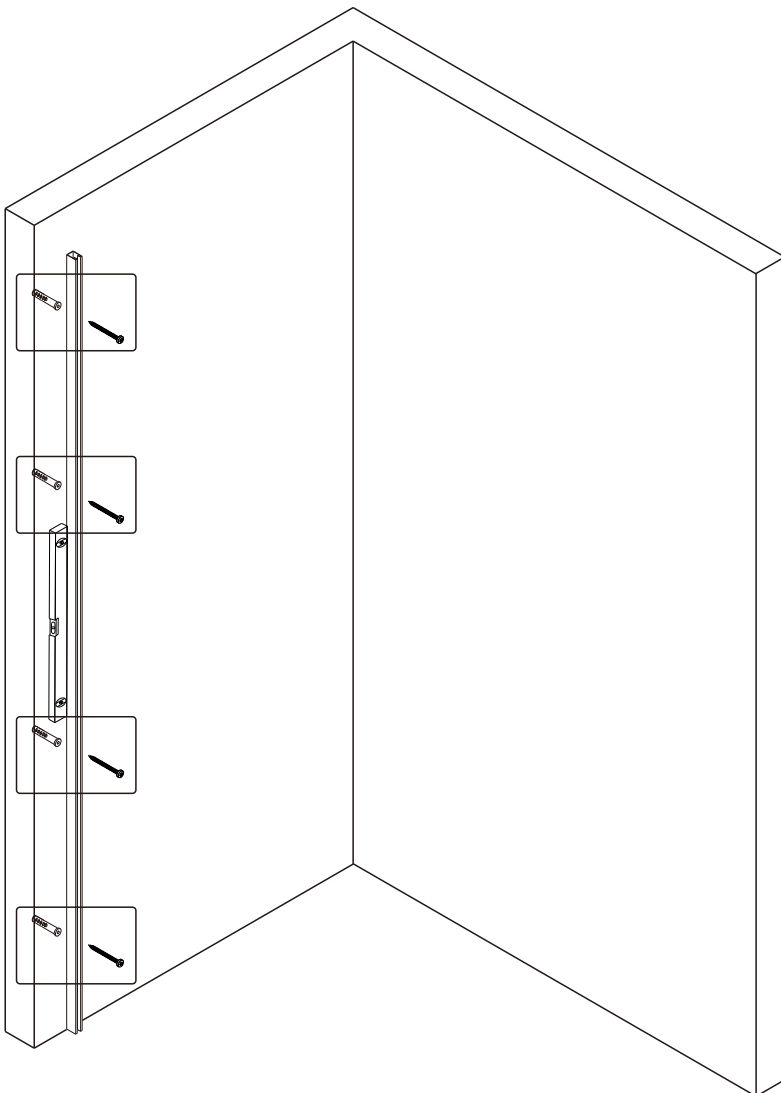

02

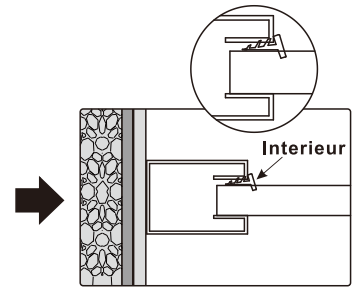
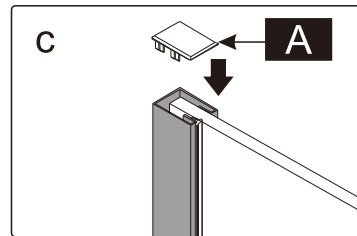
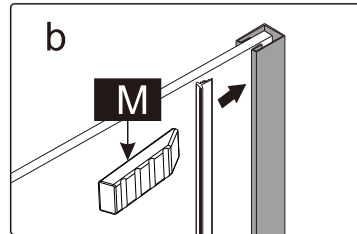
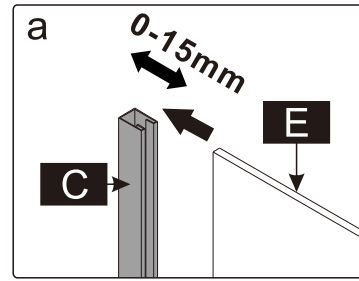
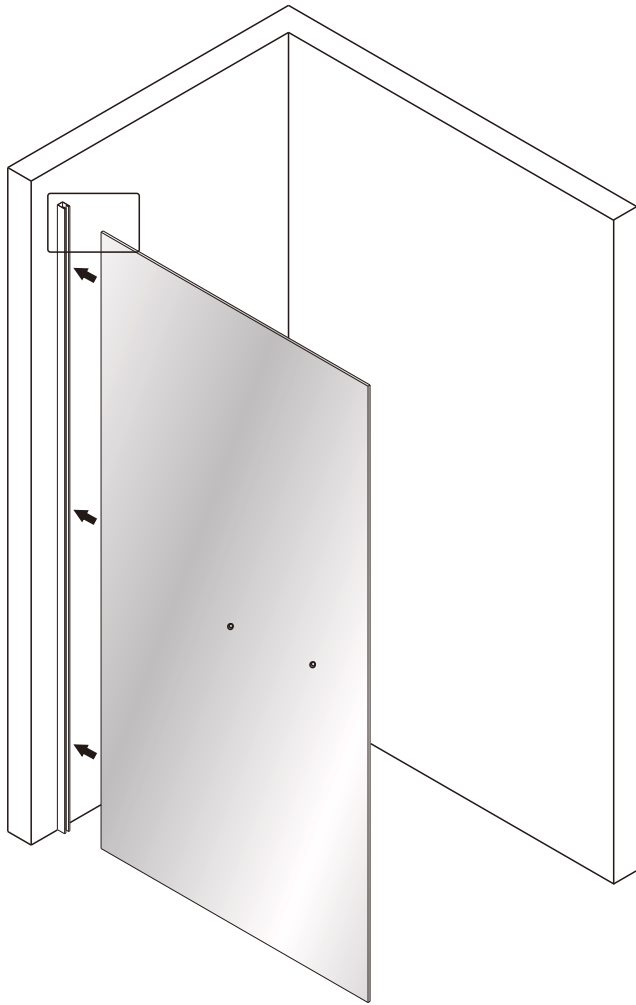

03

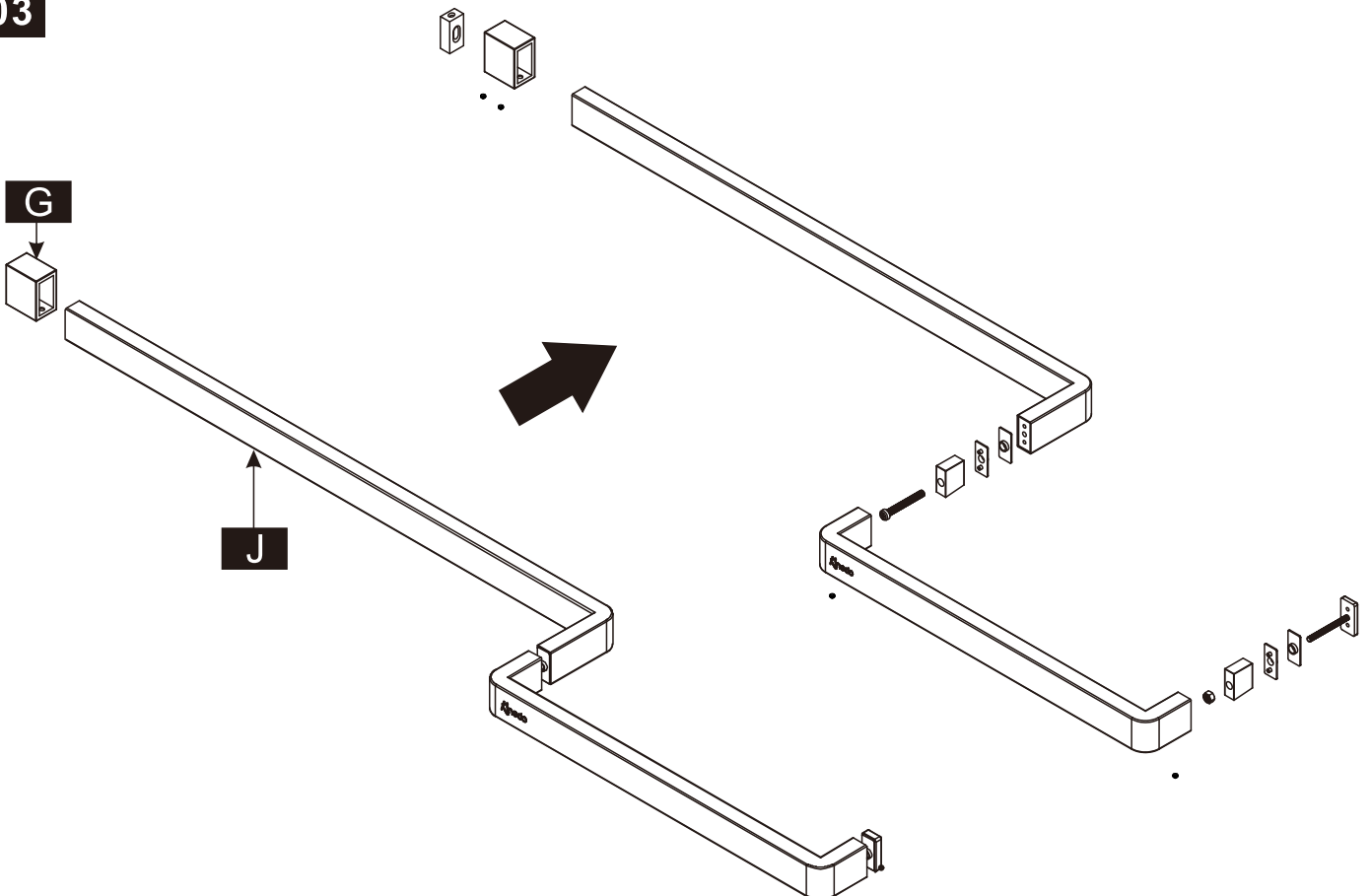

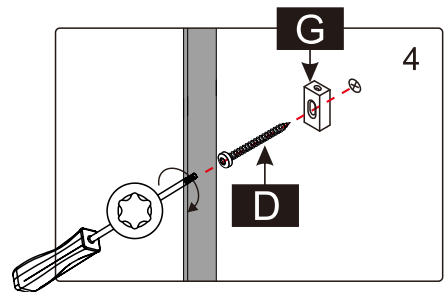
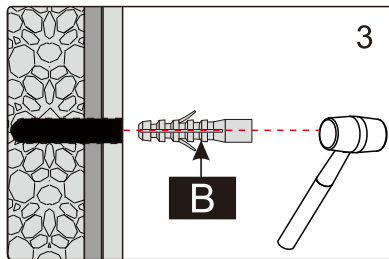
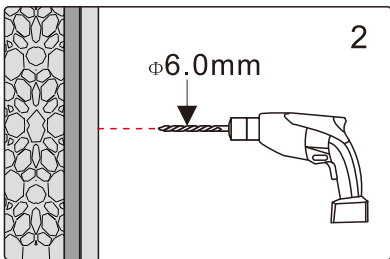
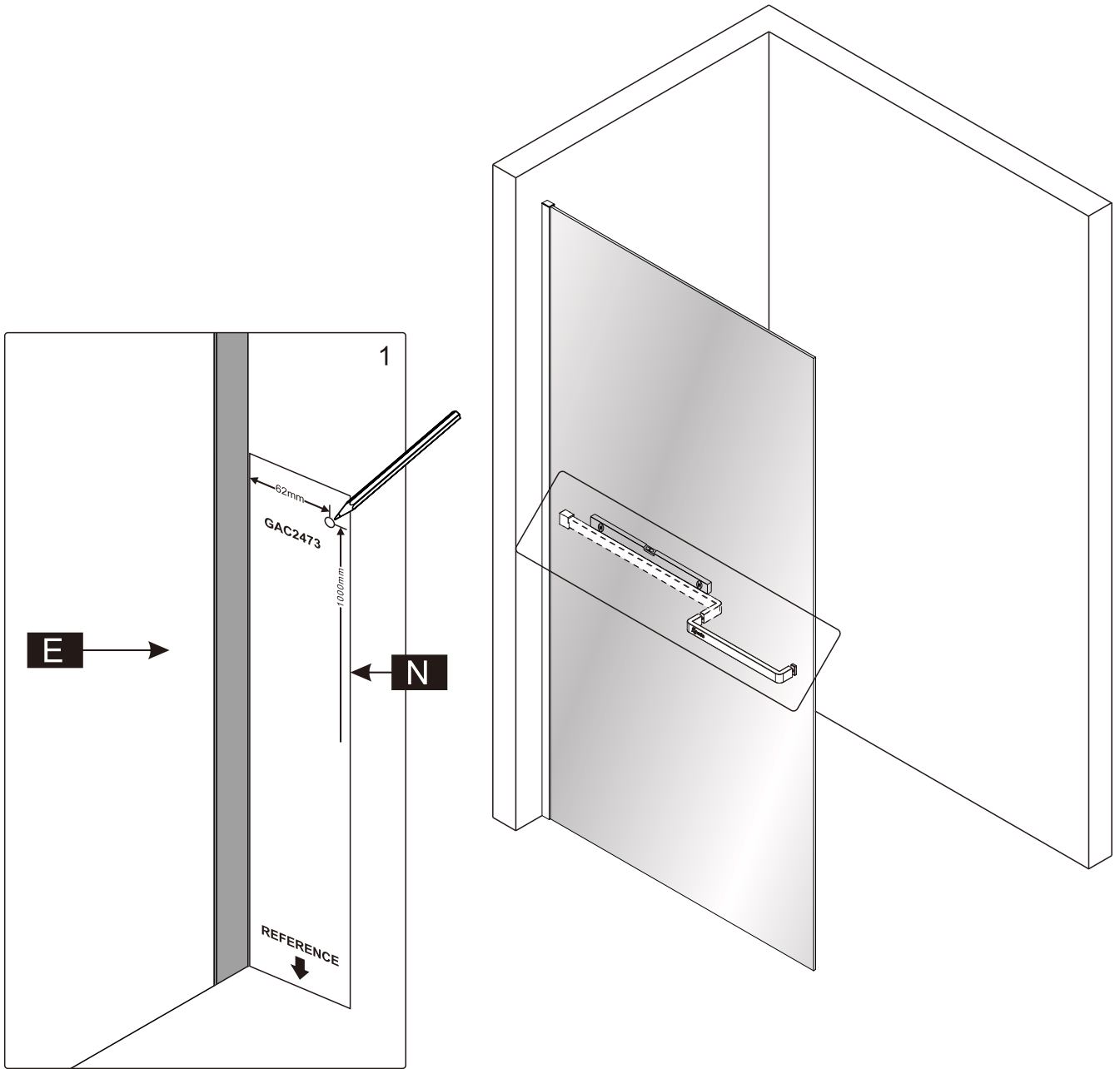



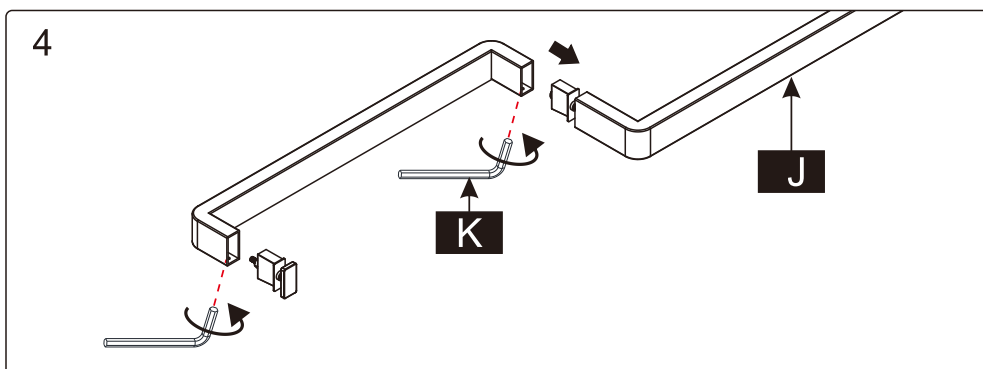
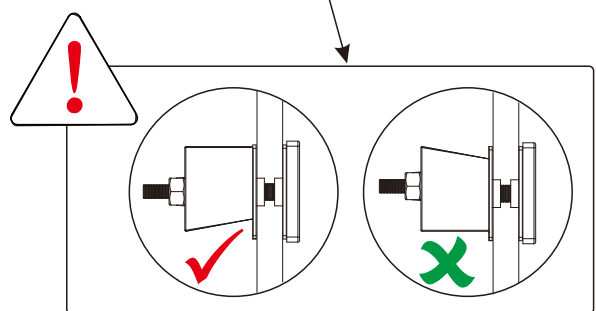
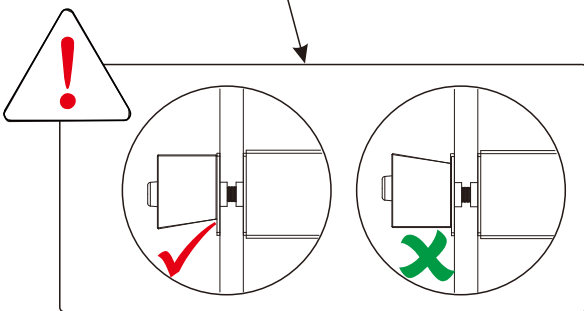
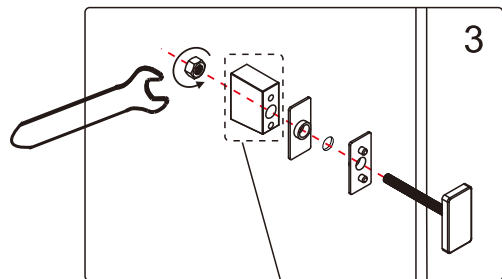
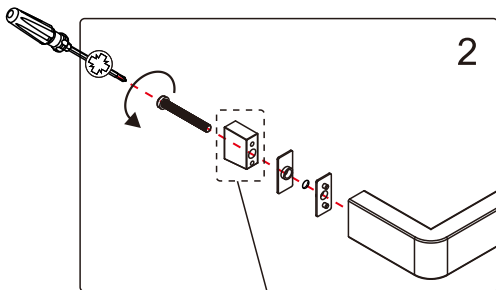
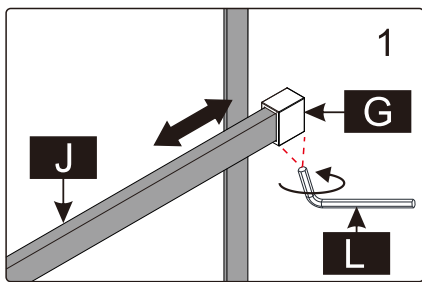
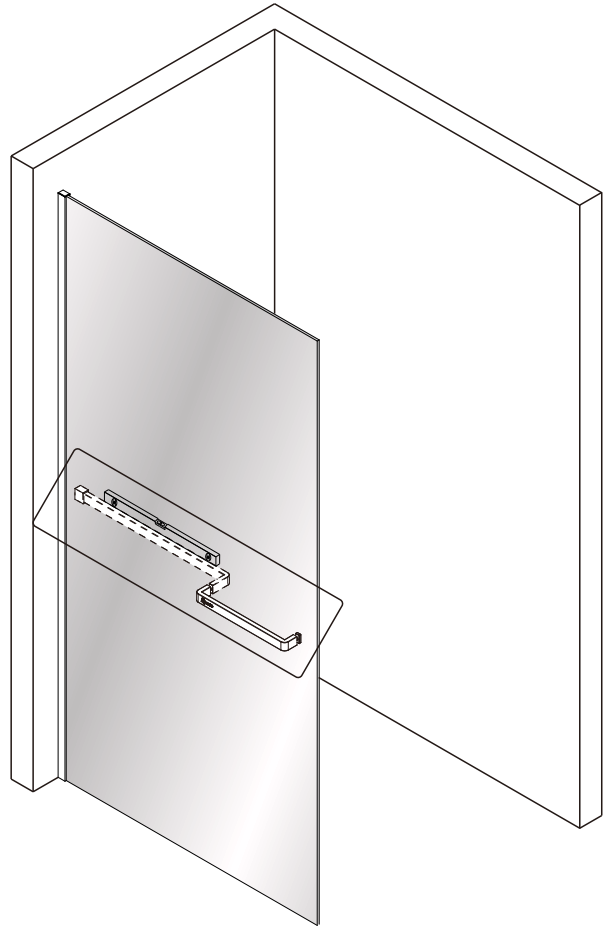

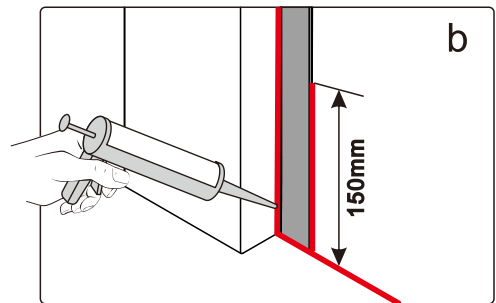
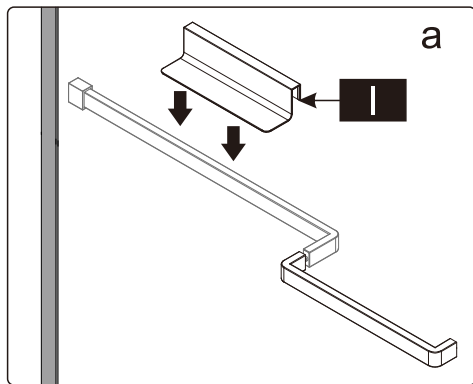
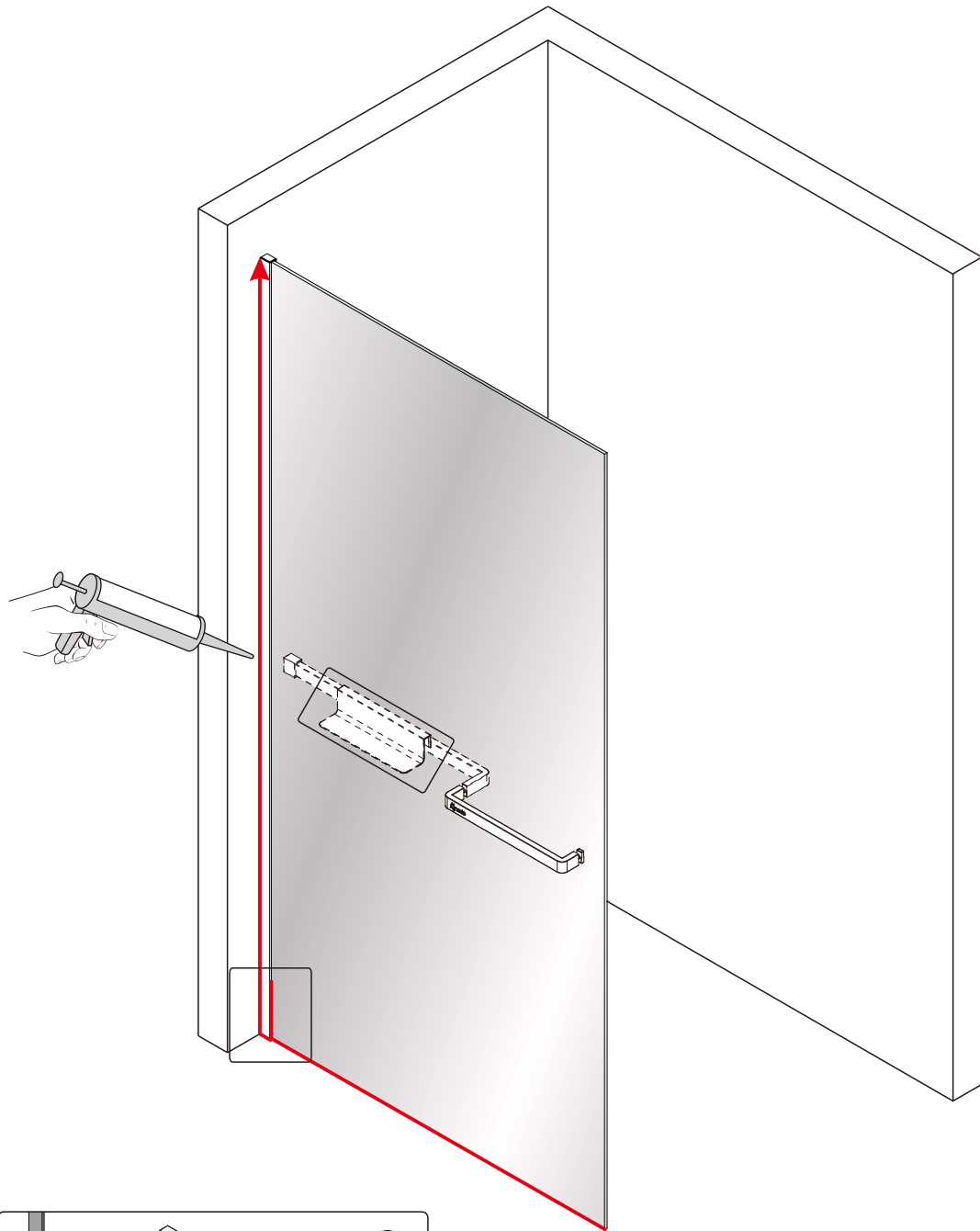

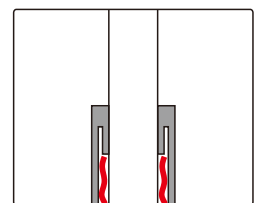
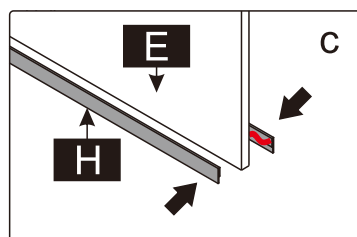
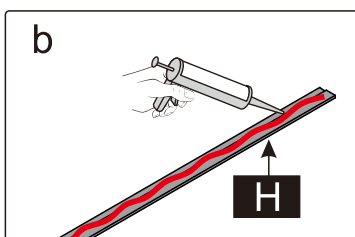
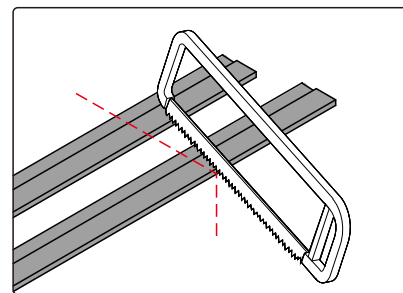
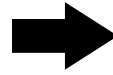
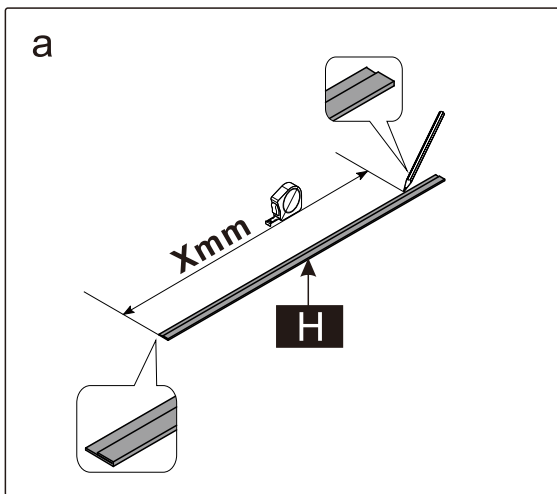
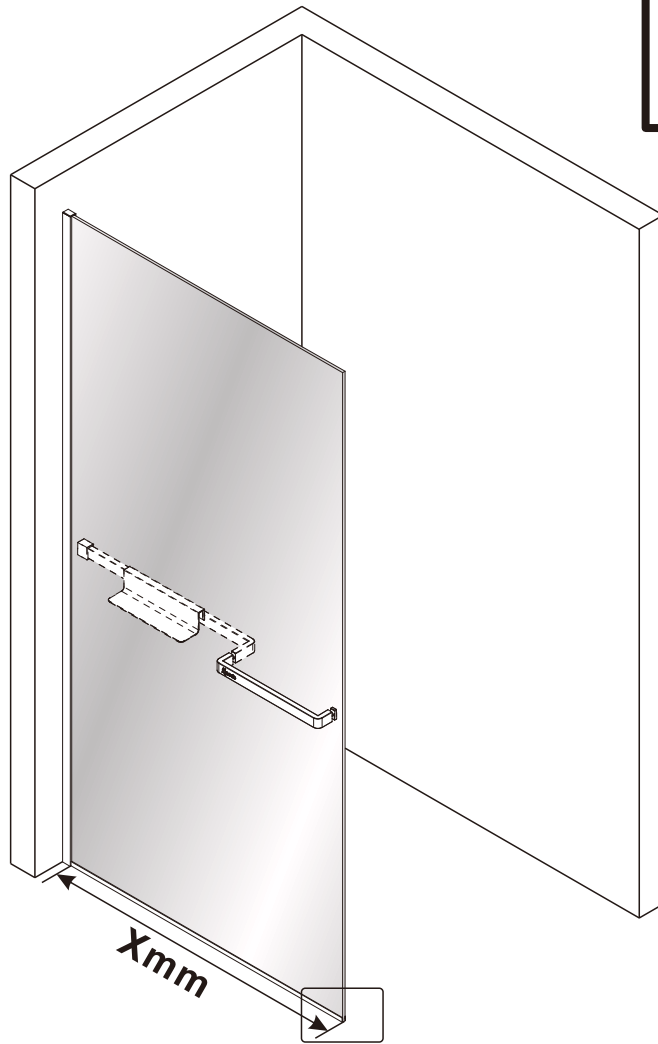
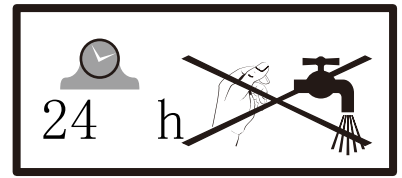





<p><b>FR</b></p> <p>Bon de garantie</p> <p><b>SCANNEZ MOI</b></p>  <p><a href="http://tiny.cc/bon-de-garantie-fr">http://tiny.cc/bon-de-garantie-fr</a></p>	<p><b>GB</b></p> <p>Guarantee</p> <p><b>SCAN ME</b></p>  <p><a href="http://tiny.cc/bon-de-garantie-gb">http://tiny.cc/bon-de-garantie-gb</a></p>
<p><b>DE</b></p> <p>Garantiekarte</p> <p><b>SCAN MICH</b></p>  <p><a href="http://tiny.cc/bon-de-garantie-de">http://tiny.cc/bon-de-garantie-de</a></p>	<p><b>NL</b></p> <p>Garantievoorwaarden</p> <p><b>SCAN MIJ</b></p>  <p><a href="http://tiny.cc/bon-de-garantie-nl">http://tiny.cc/bon-de-garantie-nl</a></p>
<p><b>ES</b></p> <p>Garantía</p> <p><b>ESCANÉAME</b></p>  <p><a href="http://tiny.cc/bon-de-garantie-es">http://tiny.cc/bon-de-garantie-es</a></p>	<p><b>IT</b></p> <p>Garanzia</p> <p><b>SCANSIONAMI</b></p>  <p><a href="http://tiny.cc/bon-de-garantie-it">http://tiny.cc/bon-de-garantie-it</a></p>
<p><b>PT</b></p> <p>Garantia</p> <p><b>ESCANEEI-ME</b></p>  <p><a href="http://tiny.cc/bon-de-garantie-pt">http://tiny.cc/bon-de-garantie-pt</a></p>	<p><b>CH</b></p> <p>Garantiekarte</p> <p><b>SCAN MICH</b></p>  <p><a href="http://tiny.cc/bon-de-garantie-ch">http://tiny.cc/bon-de-garantie-ch</a></p>
<p><b>BE</b></p> <p>Garantievoorwaarden</p> <p><b>SCAN MIJ</b></p>  <p><a href="http://tiny.cc/bon-de-garantie-be">http://tiny.cc/bon-de-garantie-be</a></p>	<p><b>AT</b></p> <p>Garantiekarte</p> <p><b>SCAN MICH</b></p>  <p><a href="http://tiny.cc/bon-de-garantie-at">http://tiny.cc/bon-de-garantie-at</a></p>



<p><b>FR</b> Conseils d'entretien</p> <p><b>SCANNEZ MOI</b></p>  <p><a href="http://tiny.cc/conseils-entretien-fr">http://tiny.cc/conseils-entretien-fr</a></p>	<p><b>GB</b> Maintenance instructions</p> <p><b>SCAN ME</b></p>  <p><a href="http://tiny.cc/conseils-entretien-gb">http://tiny.cc/conseils-entretien-gb</a></p>
<p><b>DE</b> Wartungstipps</p> <p><b>SCAN MICH</b></p>  <p><a href="http://tiny.cc/conseils-entretien-de">http://tiny.cc/conseils-entretien-de</a></p>	<p><b>NL</b> Onderhoudstips</p> <p><b>SCAN MIJ</b></p>  <p><a href="http://tiny.cc/conseils-entretien-nl">http://tiny.cc/conseils-entretien-nl</a></p>
<p><b>ES</b> Consejos de mantenimiento</p> <p><b>ESCANÉAME</b></p>  <p><a href="http://tiny.cc/conseils-entretien-es">http://tiny.cc/conseils-entretien-es</a></p>	<p><b>IT</b> Consigli per la manutenzione</p> <p><b>SCANSIONAMI</b></p>  <p><a href="http://tiny.cc/conseils-entretien-it">http://tiny.cc/conseils-entretien-it</a></p>
<p><b>PT</b> Dicas de manutenção</p> <p><b>ESCANEEI-ME</b></p>  <p><a href="http://tiny.cc/conseils-entretien-pt">http://tiny.cc/conseils-entretien-pt</a></p>	<p><b>CH</b> Wartungstipps</p> <p><b>SCAN MICH</b></p>  <p><a href="http://tiny.cc/conseils-entretien-ch">http://tiny.cc/conseils-entretien-ch</a></p>
<p><b>BE</b> Onderhoudstips</p> <p><b>SCAN MIJ</b></p>  <p><a href="http://tiny.cc/conseils-entretien-be">http://tiny.cc/conseils-entretien-be</a></p>	<p><b>AT</b> Wartungstipps</p> <p><b>SCAN MICH</b></p>  <p><a href="http://tiny.cc/conseils-entretien-at">http://tiny.cc/conseils-entretien-at</a></p>



## SERVICE APRÈS-VENTE AFTER-SALES SERVICE

### FRANCE

+33 (0)2 40 21 29 45

### UK

+44 (0)20 8842 0033

### IRELAND

+353 04697 33102

### DEUTSCHLAND

+49 (0) 6074 / 30928 0

### ITALIA

+39 02 30559420

### ÖSTEREICH

+43 1 710 60 70

### SUISSE/SCHWEIZ

+41 (0)32 631 04 74

### ESPAÑA

+34 93 544 60 76

### NEDERLAND

+31 475 487 100

### BELGIQUE/BELGIË

+31 475 487 100

### РОССИЯ

+7 495 258-29-51

### PORTUGAL

+351 219 112 785



AQUAPRODUCTION, Site industriel,  
F - 44680 Chaumes-en-Retz

24

### EN 14428

Paroi de douche, fabriquée en verre de silicate  
sodo-calcique de sécurité trempé thermiquement

Aptitude au nettoyage : réussite

Résistance à l'impact/propriétés de fragmentation : réussite

Durabilité : réussite